

CATALOGO



INDICE

- Pag 01) Raccordi filettati**
- Pag 02) Raccordi filettati, Rubinetti a spillo**
- Pag 03) Raccordi istantanei per Rilsan**
- Pag 04) Raccordi a Calzamento**
- Pag 05-06) Raccordi ad Ogiva**
- Pag 07) Raccordi a “Baionetta”**
- Pag 08-09) Innesti e Rubinetti rapidi**
- Pag 10) Tubi**
- Pag 11) Fascette per Tubi e Accessori**
- Pag 12) Pistole per aria e Aerografi**
- Pag 13) Accessori per Compressori**
- Pag 14) Silenziatori e Paracolpi**
- Pag 15-16) Gruppi FRL (Filtri, Regolatori di Pressione, Lubrificatori)**
- Pag 17) Manometri, Vuotometri**
- Pag 18) Rubinetti a Sfera**
- Pag 19) Valvole a Sfera ad azionamento pneumatico**
- Pag 20) Elettrovalvole per Aria, Acqua, Gas, Vapore**
- Pag 21-22-23) Valvole Pneumatiche ed Elettrovalvole**
- Pag 24-25-26) Cilindri Pneumatici ed accessori**
- Pag 27) Bloccaggi Manuali e pneumatici**
- Pag 28) Cilindri Idraulici e Moltiplicatori di Pressione**
- Pag 29) Lubrificazione Forzata**
- Pag 30) Antivibranti**
- Pag 31) Generatori di Vuoto e Accessori**
- Pag 32) Valvole ed Elettrovalvole Pneumatiche ed ISO**

AIR MECCANICA S.n.c. di Romani Gianfranco e Rossano

Via Coriano, 58 – Blocco 32/E

47900 RIMINI (RN)

Tel. 0541 387704 – Fax 0541 382510 – e-mail: airmeccanica@libero.it

NC NIPPLO CONICO -2500*-2510-			
COD. ART.	MISURA	PREZZO	
NC88*	1/8		
NC44*	1/4		
NC33*	3/8		
NC22*	1/2		
NC77*	3/4		
NC11	1"		
Filetto conico			
NC84	1/8 - 1/4		
NC83	1/8 - 3/8		
NC43	1/4 - 3/8		
NC42	1/4 - 1/2		
NC32	3/8 - 1/2		
NC27	1/2 - 3/4		
NC71	3/4 - 1"		

ND NIPPLO CILINDR. -2501*-2511-			
COD. ART.	MISURA	PREZZO	
ND55*	M5		
ND88*	1/8		
ND44*	1/4		
ND33*	3/8		
ND22*	1/2		
Filetto cilindrico			
ND58	M5 - 1/8		
ND84	1/8 - 1/4		
ND83	1/8 - 3/8		
ND43	1/4 - 3/8		
ND42	1/4 - 1/2		
ND32	3/8 - 1/2		

A richiesta: tipi alta pressione NZ

RC RIDUZIONE CON. -2530*-2520-			
COD. ART.	MISURA	PREZZO	
RC48*	1/4M-1/8F		
RC38*	3/8M-1/8F		
RC34*	3/8M-1/4F		
RC28*	1/2M-1/8F		
RC24*	1/2M-1/4F		
RC23*	1/2M-3/8F		
RC72*	3/4M-1/2F		
RC73	3/4M-3/8F		
Filetto conico			
RC88	1/8M-1/8F		
RC84	1/8M-1/4F		
RC83	1/8M-3/8F		
RC44	1/4M-1/4F		
RC43	1/4M-3/8F		
RC42	1/4M-1/2F		
RC33	3/8M-3/8F		
RC32	3/8M-1/2F		
RC22	1/2M-1/2F		

RD RIDUZIONE CIL. -2531*-2521-			
COD. ART.	MISURA	PREZZO	
RD85*	1/8M-M5F		
RD48*	1/4M-1/8F		
RD38*	3/8M-1/8F		
RD34*	3/8M-1/4F		
RD28*	1/2M-1/8F		
RD24*	1/2M-1/4F		
RD23*	1/2M-3/8F		
RD12	1"M-1/2F		
RD17	1"M-3/4F		
Filetto cilindrico			
RD58	M5M-1/8F		
RD88	1/8M-1/8F		
RD84	1/8M-1/4F		
RD83	1/8M-3/8F		
RD44	1/4M-1/4F		
RD43	1/4M-3/8F		
RD42	1/4M-1/2F		
RD33	3/8M-3/8F		
RD32	3/8M-1/2F		
RD22	1/2M-1/2F		
RD27	1/2M-3/4F		
RD71	3/4M-1"F		

Da 3/4 a 1" in ottone naturale.

RB RIDUZIONI A SCOMPARSA			
COD. ART.	MISURA	PREZZO	
RB85	1/8 - M5		
RB48	1/4 - 1/8		
RB34	3/8 - 1/4		
RB38	3/8 - 1/8		
RB24	1/2 - 1/4		
RB23	1/2 - 3/8		

A= tutto filetto B= impronta brugola

MA MANICOTTO -2543*-2553-			
COD. ART.	MISURA	PREZZO	
MA55*	M5		
MA88*	1/8		
MA44*	1/4		
MA33*	3/8		
MA22*	1/2		
MA77	3/4		
MA11	1"		
Filetto cilindrico			
MA58	M5-1/8		
MA84	1/8-1/4		
MA83	1/8-3/8		
MA82	1/8-1/2		
MA43	1/4-3/8		
MA42	1/4-1/2		
MA32	3/8-1/2		
MA27	1/2-3/4		
MA71	3/4-1"		

PL PROLUNGA CILINDR. -2525*-			
COD. ART.	MISURA	PREZZO	
P8FC*	1/8-h16		
P8FL*	1/8-h36		
P4FC*	1/4-h27		
P4FL*	1/4-h43		
P3FC	3/8-h15		
P3FL	3/8-h30		
P2FC	1/2-h15		
P2FL	1/2-h30		

h= altezza escluso filetto esterno.

RG RACCORDO GIREVOLE -2541-			
COD. ART.	MISURA	PREZZO	
RG88	1/8M-1/8F		
RG44	1/4M-1/4F		
RG33	3/8M-3/8F		

TTE TAPPO CILINDRICO -2611*-			
COD. ART.	MISURA	PREZZO	
TTE5*	M5		
TTE8*	1/8		
TTE4*	1/4		
TTE3*	3/8		
TTE2*	1/2		
TTE7	3/4		
TTE1	1"		

TTL TAPPO A BRUGOLA CILINDRICO			
COD. ART.	MISURA	PREZZO	
TTL8	1/8		
TTL4	1/4		
TTL3	3/8		
TTL2	1/2		

A richiesta: TTC= filetto conico.

TTB TAPPO A BRUGOLA CILINDRICO			
COD. ART.	MISURA	PREZZO	
TTB5	M5		
TTB8	1/8		
TTB4	1/4		
TTB3	3/8		
TTB2	1/2		

TTF TAPPO FEMMINA -2613*-			
COD. ART.	MISURA	PREZZO	
TTF8*	1/8		
TTF4*	1/4		
TTF3*	3/8		
TTF2*	1/2		
TTF7	3/4		
TTF1	1"		

DA DADO -1253*-			
COD. ART.	MISURA	PREZZO	
DA8*	1/8		
DA4*	1/4		
DA3	3/8		
DA2	1/2		

RLM RACC. CURVO CONICO -2010-			
COD. ART.	MISURA	PREZZO	
RLM8	1/8		
RLM4	1/4		
RLM3	3/8		
RLM2	1/2		

RLF RACC. CURVO -2013*-			
COD. ART.	MISURA	PREZZO	
RLF8*	1/8		
RLF4*	1/4		
RLF3*	3/8		
RLF2*	1/2		
RLF7	3/4		
RLF1	1"		

Da 3/4 a 1" in ottone naturale.

RLA RACC. CURVO CONICO -2020*-			
COD. ART.	MISURA	PREZZO	
RLA5*	M5		
RLA8*	1/8		
RLA4*	1/4		
RLA3*	3/8		
RLA2*	1/2		
RLA7	3/4		
RLA1	1"		

RLG RACC. ORIENTABILE -2023-			
COD. ART.	MISURA	PREZZO	
RLG5	M5		
RLG8	1/8		
RLG4	1/4		
RLG3	3/8		

Utilizzare con raccordi PD - 1631

RLS RACCORDO -L- CUBICO			
COD. ART.	MISURA	PREZZO	
RLS5	M5		
RLS8	1/8		
RLS4	1/4		
RLS3	3/8		

RTS RACCORDO -T- CUBICO			
COD. ART.	MISURA	PREZZO	
RTS8	1/8		
RTS4	1/4		
RTS3	3/8		

ACCESSORI PER RACCORDI - RUBINETTI

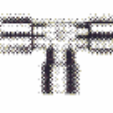
RTFFF	RACCORDO -2003*-			
	COD. ART.	MISURA	Conf.	PREZZO
	RTFFF8*	1/8	100	
	RTFFF4*	1/4	50	
	RTFFF3*	3/8	25	
	RTFFF2*	1/2	20	
	RTFFF1	3/4	10	
	RTFFF1	1"	10	

① 3/4-1" in ottone naturale.

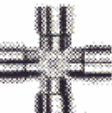
RXF	RACCORDO A CROCE			
	COD. ART.	MISURA	Conf.	PREZZO
	RXF8	1/8		
	RXF4	1/4		
	RXF3	3/8		
	RXF2	1/2		

①

RG	RACCORDO A RESCA -2601*-			
	COD. ART.	MISURA	Conf.	PREZZO
	RG045*	4,5-M5	100	
	RG078*	7-1/8	100	
	RG074*	7-1/4	100	
	RG098*	9-1/8	100	
	RG094*	9-1/4	100	
	RG093*	9-3/8	100	
	RG104	10-1/4	50	
	RG124*	12-1/4	100	
	RG123*	12-3/8	100	
	RG122*	12-1/2	100	
	RG143	14-3/8	50	
	RG142	14-1/2	50	
	RG173*	17-3/8	50	
	RG172*	17-1/2	50	
	RG207	20-3/4	10	
	RG257	25-3/4	10	
	RG251	25-1"	10	

①

RTMMF	RACCORDO -2050-			
	COD. ART.	MISURA	Conf.	PREZZO
	RTMMF8	1/8	50	
	RTMMF4	1/4	50	
	RTMMF3	3/8	25	
	RTMMF2	1/2	20	

①

RXM	RACCORDO A CROCE			
	COD. ART.	MISURA	Conf.	PREZZO
	RXM8	1/8		
	RXM4	1/4		
	RXM3	3/8		
	RXM2	1/2		

①

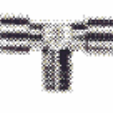
RTFMF	RACCORDO -2060-			
	COD. ART.	MISURA	Conf.	PREZZO
	RTFMF8	1/8	50	
	RTFMF4	1/4	50	
	RTFMF3	3/8	50	
	RTFMF2	1/2	25	

①

RX	RIPARTITORE -3033-			
	COD. ART.	MISURA	Conf.	PREZZO
	RX8	1/8	50	
	RX4	1/4	40	
	RX3	3/8	24	
	RX2	1/2	12	

①

PP	RACCORDO PASSA-PARETE			
	COD. ART.	MISURA	Conf.	PREZZO
	PP88	1/8		
	PP44	1/4		
	PP33	3/8		
	PP22	1/2		

① 1/2 in ottone naturale.

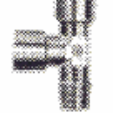
RTMFF	RACCORDO -2070-			
	COD. ART.	MISURA	Conf.	PREZZO
	RTMFF8	1/8	100	
	RTMFF4	1/4	50	
	RTMFF3	3/8	50	
	RTMFF2	1/2	25	

①

RXD	RIPARTITORE LINEARE		
	COD. ART.	MISURA	PREZZO
	RX8D3	E. 1/4 - 3 Usc. 1/8	
	RX8D4	E. 1/4 - 4 Usc. 1/8	
	RX8D5	E. 1/4 - 5 Usc. 1/8	
	RX8D6	E. 1/4 - 6 Usc. 1/8	
	RX4D3	E. 3/8 - 3 Usc. 1/4	
	RX4D4	E. 3/8 - 4 Usc. 1/4	
	RX4D5	E. 3/8 - 5 Usc. 1/4	
	RX4D6	E. 3/8 - 6 Usc. 1/4	

①

GR	GIUNTO ROTANTE		
	COD. ART.	MISURA	PREZZO
	GR8	1/8 - max 550 g.	
	GR4	1/4 - max 550 g.	
	GR3	3/8 - max 300 g.	
	GR2	1/2 - max 200 g.	

① g. = giri al minuto

RTMMM	RACCORDO -2080-			
	COD. ART.	MISURA	Conf.	PREZZO
	RTMMM	1/8	50	
	RTMMM	1/4	50	
	RTMMM	3/8	25	
	RTMMM	1/2	25	

①

RXT	RIPART. USCITE CONTRAPP.		
	COD. ART.	MISURA	PREZZO
	RX8T4	E. 1/4 - 4 Usc. 1/8	
	RX8T6	E. 1/4 - 6 Usc. 1/8	
	RX8T1	E. 1/4 - 10 Usc. 1/8	
	RX4T4	E. 3/8 - 4 Usc. 1/4	
	RX4T6	E. 3/8 - 6 Usc. 1/4	
	RX4T1	E. 3/8 - 10 Usc. 1/4	

①

RUV	RUBINETTO A SPILLO -2820-			
	COD. ART.	MISURA	Conf.	PREZZO
	RUV8MF	1/8	25	
	RUV4MF	1/4	25	
	RUV3MF	3/8	10	
	RUV2MF	1/2	10	

①

RTMFM	RACCORDO -2090-			
	COD. ART.	MISURA	Conf.	PREZZO
	RTMFM8	1/8	50	
	RTMFM4	1/4	50	
	RTMFM3	3/8	25	
	RTMFM2	1/2	25	

①

RXD	RIPARTITORE LIN. OTTONE		
	COD. ART.	MISURA	PREZZO
	RX3D3	E. 3/4 - 3 Usc. 3/8	
	RX3D4	E. 3/4 - 4 Usc. 3/8	
	RX3D5	E. 3/4 - 5 Usc. 3/8	
	RX3D6	E. 3/4 - 6 Usc. 3/8	
	RX2D3	E. 3/4 - 3 Usc. 1/2	
	RX2D4	E. 3/4 - 4 Usc. 1/4	
	RX2D5	E. 1" - 5 Usc. 1/2	

①

RUV	RUBINETTO A SPILLO -2830-			
	COD. ART.	MISURA	Conf.	PREZZO
	RUV8FF	1/8	25	
	RUV4FF	1/4	25	
	RUV3FF	3/8	10	
	RUV2FF	1/2	10	

①

RYM	RACCORDO DEVIATORE			
	COD. ART.	MISURA	Conf.	PREZZO
	RYM8	1/8		
	RYM4	1/4		
	RYM3	3/8		
	RYM2	1/2		

①

RGD	RACCORDO A RESCA CONGIUNT.			
	COD. ART.	MISURA	Conf.	PREZZO
	RGD07	7		
	RGD09	9		
	RGD10	10		

①

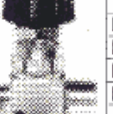
RUVF	RUBINETTO A SPILLO -2829-			
	COD. ART.	MISURA	Conf.	PREZZO
	RUV8MP	1/8	25	
	RUV4MP	1/4	25	
	RUV3MP	3/8	10	
	RUV2MP	1/2	10	

① Passa-parete

RYF	RACCORDO DEVIATORE			
	COD. ART.	MISURA	Conf.	PREZZO
	RYF8	1/8		
	RYF4	1/4		
	RYF3	3/8		
	RYF2	1/2		

①

RGF	RACCORDO A RESCA FEMM.			
	COD. ART.	MISURA	Conf.	PREZZO
	RGF078	7 - 1/8	25	
	RGF074	7 - 1/4	25	
	RGF094	9 - 1/4	25	
	RGF093	9 - 3/8	25	
	RGF132	13 - 1/2	25	

①

RUVF	RUBINETTO A SPILLO -2839-			
	COD. ART.	MISURA	Conf.	PREZZO
	RUV8FP	1/8	25	
	RUV4FP	1/4	25	
	RUV3FP	3/8	10	
	RUV2FP	1/2	10	

① Passa-parete

BS

RACCORDO -6510-		
COD. ART.	MISURA	PREZZO
BS048	4-1/8	
BS044	4-1/4	
BS058	5-1/8	
BS054	5-1/4	
BS068	6-1/8	
BS064	6-1/4	
BS088	8-1/8	
BS084	8-1/4	
BS083	8-3/8	
BS104	10-1/4	
BS103	10-3/8	
BS102	10-1/2	
BS124	12-1/4	
BS123	12-3/8	
BS122	12-1/2	
BS143	14-3/8	
BS142	14-1/2	

MN

RACCORDO -6500-		
COD. ART.	MISURA	PREZZO
MN046	4-M6	
MN048	4-1/8	
MN068	6-1/8	
MN064	6-1/4	
MN088	8-1/8	
MN084	8-1/4	
MN104	10-1/4	

TS

RACCORDO -6430-		
COD. ART.	MISURA	PREZZO
TS048	4-1/8	
TS068	6-1/8	
TS064	6-1/4	
TS088	8-1/8	
TS084	8-1/4	
TS104	10-1/4	
TS123	12-3/8	

BZ

RACCORDO -6511-		
COD. ART.	MISURA	PREZZO
BZ045	4-M5	
BZ048	4-1/8	
BZ044	4-1/4	
BZ065	6-M5	
BZ068	6-1/8	
BZ088	8-1/8	
BZ084	8-1/4	

MI

RACCORDO -6520-		
COD. ART.	MISURA	PREZZO
MI046	4-M6	
MI048	4-1/8	
MI058	5-1/8	
MI054	5-1/4	
MI068	6-1/8	
MI064	6-1/4	
MI088	8-1/8	
MI084	8-1/4	
MI083	8-3/8	
MI104	10-1/4	
MI103	10-3/8	
MI102	10-1/2	
MI124	12-1/4	
MI123	12-3/8	
MI122	12-1/2	
MI143	14-3/8	
MI142	14-1/2	

TR

RACCORDO -6440-		
COD. ART.	MISURA	PREZZO
TR048	4-1/8	
TR068	6-1/8	
TR064	6-1/4	
TR088	8-1/8	
TR084	8-1/4	
TR104	10-1/4	
TR123	12-3/8	

BI

RACCORDO -6463-		
COD. ART.	MISURA	PREZZO
BI045	4-M5	
BI048	4-1/8	
BI068	6-1/8	
BI064	6-1/4	
BI088	8-1/8	
BI084	8-1/4	
BI104	10-1/4	

MC

RACCORDO -6521-		
COD. ART.	MISURA	PREZZO
MC045	4-M5	
MC048	4-1/8	
MC068	6-1/8	
MC064	6-1/4	
MC088	8-1/8	
MC084	8-1/4	
MC104	10-1/4	

TS

RACCORDO -6540-		
COD. ART.	MISURA	PREZZO
TS04	4 mm	
TS05	5 mm	
TS06	6 mm	
TS08	8 mm	
TS10	10 mm	
TS12	12mm	
TS14	14 mm	

BS

RACCORDO -6580-		
COD. ART.	MISURA	PREZZO
BS04	4 mm	
BS05	5 mm	
BS06	6 mm	
BS08	8 mm	
BS10	10 mm	
BS12	12mm	
BS14	14 mm	

MS

RACCORDO -SISTEM P.-		
COD. ART.	MISURA	PREZZO
MS048	4-1/8	
MS068	6-1/8	
MS064	6-1/4	
MS088	8-1/8	
MS084	8-1/4	
MS104	10-1/4	
MS103	10-3/8	

TO

RACCORDO -6620-		
COD. ART.	MISURA	PREZZO
TO048	4-1/8	
TO058	5-1/8	
TO068	6-1/8	
TO064	6-1/4	
TO088	8-1/8	
TO084	8-1/4	
TO104	10-1/4	

BG

RACCORDO -6590-		
COD. ART.	MISURA	PREZZO
BG04	4 mm	
BG05	5 mm	
BG06	6 mm	
BG08	8 mm	
BG10	10 mm	
BG12	12mm	
BG14	14 mm	

MI

RACCORDO -6550-		
COD. ART.	MISURA	PREZZO
MI04	4 mm	
MI05	5 mm	
MI06	6 mm	
MI08	8 mm	
MI10	10 mm	
MI12	12mm	
MI14	14 mm	

UD

RACCORDO -6450-		
COD. ART.	MISURA	PREZZO
UD045	4-M5	
UD048	4-1/8	
UD068	6-1/8	
UD088	8-1/8	
UD084	8-1/4	

IS

RACCORDO -6800-		
COD. ART.	MISURA	PREZZO
IS064	6-4	
IS084	8-4	
IS086	8-6	
IS106	10-6	
IS108	10-8	

GO

RACCORDO -6610-		
COD. ART.	MISURA	PREZZO
GO045	4-M5	
GO048	4-1/8	
GO068	6-1/8	
GO064	6-1/4	
GO088	8-1/8	
GO084	8-1/4	
GO104	10-1/4	

UD

RACCORDO -6560-		
COD. ART.	MISURA	PREZZO
UD04	4 mm	
UD06	6 mm	
UD08	8 mm	

IM

RACCORDO -6811-		
COD. ART.	MISURA	PREZZO
IM048	4-1/8	
IM068	6-1/8	
IM064	6-1/4	
IM088	8-1/8	
IM084	8-1/4	
IM104	10-1/4	
IM123	12-3/8	

Fc

RACCORDO -6950-		
COD. ART.	MISURA	PREZZO
RG04	4 mm	
RG05	5 mm	
RG06	6 mm	
RG08	8 mm	
RG10	10 mm	
RG12	12mm	
RG14	14 mm	

RM

RACCORDO -6600-		
COD. ART.	MISURA	PREZZO
RM04	4 mm	
RM05	5 mm	
RM06	6 mm	
RM08	8 mm	
RM10	10 mm	

FO	RACCORDO -1510-		
	COD. ART.	MISURA	PREZZO
	FO058	5/3-1/8	
	FO068	6/4-1/8	
	FO064	6/4-1/4	
	FO063	6/4-3/8	
	FO062	6/4-1/2	
	FO088	8/6-1/8	
	FO084	8/6-1/4	
	FO083	8/6-3/8	
	FO082	8/6-1/2	
	FO108	10/8-1/8	
	FO104	10/8-1/4	
	FO103	10/8-3/8	
	FO102	10/8-1/2	
	FO123	12/10-3/8	
	FO122	12/10-1/2	
	FO152	15/12,5-1/2	

LO	RACCORDO -1500-		
	COD. ART.	MISURA	PREZZO
	LO068	6/4-1/8	
	LO064	6/4-1/4	
	LO063	6/4-3/8	
	LO088	8/6-1/8	
	LO084	8/6-1/4	
	LO083	8/6-3/8	
	LO082	8/6-1/2	
	LO108	10/8-1/8	
	LO104	10/8-1/4	
	LO103	10/8-3/8	
	LO102	10/8-1/2	
	LO123	12/10-3/8	
	LO122	12/10-1/2	
	LO152	15/12,5-1/2	

VT	RACCORDO -1410-		
	COD. ART.	MISURA	PREZZO
	VT068	6/4-1/8	
	VT064	6/4-1/4	
	VT063	6/4-3/8	
	VT088	8/6-1/8	
	VT084	8/6-1/4	
	VT083	8/6-3/8	
	VT108	10/8-1/8	
	VT104	10/8-1/4	
	VT103	10/8-3/8	
	VT102	10/8-1/2	
	VT123	12/10-3/8	
	VT122	12/10-1/2	
	VT152	15/12,5-1/2	

FE	RACCORDO -1511-		
	COD. ART.	MISURA	PREZZO
	FE068	6/4-1/8	
	FE064	6/4-1/4	
	FE088	8/6-1/8	
	FE084	8/6-1/4	
	FE104	10/8-1/4	
	FE103	10/8-3/8	
	FE123	12/10-3/8	

LC	RACCORDO -1541-		
	COD. ART.	MISURA	PREZZO
	LC068	6/4-1/8	
	LC064	6/4-1/4	
	LC088	8/6-1/8	
	LC084	8/6-1/4	
	LC104	10/8-1/4	

GIREVOLE

VI	RACCORDO -1420-		
	COD. ART.	MISURA	PREZZO
	VI068	6/4-1/8	
	VI064	6/4-1/4	
	VI088	8/6-1/8	
	VI084	8/6-1/4	
	VI104	10/8-1/4	
	VI103	10/8-3/8	
	VI123	12/10-3/8	

FG	RACCORDO -1560-		
	COD. ART.	MISURA	PREZZO
	FG068	6/4-1/8	
	FG064	6/4-1/4	
	FG088	8/6-1/8	
	FG084	8/6-1/4	
	FG104	10/8-1/4	
	FG103	10/8-3/8	
	FG123	12/10-3/8	

GIREVOLE

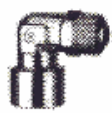
LI	RACCORDO -1493-		
	COD. ART.	MISURA	PREZZO
	LI068	6/4-1/8	
	LI064	6/4-1/4	
	LI088	8/6-1/8	
	LI084	8/6-1/4	
	LI104	10/8-1/4	
	LI123	12/10-3/8	

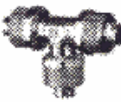
VT	RACCORDO -1540-		
	COD. ART.	MISURA	PREZZO
	VT06	6/4	
	VT08	8/6	
	VT10	10/8	
	VT12	12/10	
	VT15	15/12,5	

FI	RACCORDO -1463-		
	COD. ART.	MISURA	PREZZO
	FI068	6/4-1/8	
	FI064	6/4-1/4	
	FI088	8/6-1/8	
	FI084	8/6-1/4	
	FI104	10/8-1/4	
	FI103	10/8-3/8	
	FI123	12/10-3/8	

LO	RACCORDO -1550-		
	COD. ART.	MISURA	PREZZO
	LO06	6/4	
	LO08	8/6	
	LO10	10/8	
	LO12	12/10	
	LO15	15/12,5	

VR	RACCORDO -1620-		
	COD. ART.	MISURA	PREZZO
	VR068	6/4-1/8	
	VR064	6/4-1/4	
	VR088	8/6-1/8	
	VR084	8/6-1/4	
	VR104	10/8-1/4	
	VR103	10/8-3/8	
	VR123	12/10-3/8	

ORIENTABILE

FO	RACCORDO -1580-		
	COD. ART.	MISURA	PREZZO
	FO06	6/4	
	FO08	8/6	
	FO10	10/8	
	FO12	12/10	
	FO15	15/12,5	

LU	RACCORDO -1610-		
	COD. ART.	MISURA	PREZZO
	LU068	6/4-1/8	
	LU064	6/4-1/4	
	LU088	8/6-1/8	
	LU084	8/6-1/4	
	LU108	10/8-1/8	
	LU104	10/8-1/4	
	LU103	10/8-3/8	

ORIENTABILE

VC	RACCORDO -1600-		
	COD. ART.	MISURA	PREZZO
	VC06	6/4	
	VC08	8/6	
	VC10	10/8	
	VC12	12/10	
	VC15	15/12,5	

FR	RACCORDO -1590-		
	COD. ART.	MISURA	PREZZO
	FR06	6/4	
	FR08	8/6	
	FR10	10/8	
	FR12	12/10	
	FR15	15/12,5	

PD	RACCORDO -1631-		
	COD. ART.	MISURA	PREZZO
	PD51	M5	
	PD81	1/8	
	PD41	1/4	
	PD31	3/8	
	PD82	1/8	
	PD42	1/4	
	PD32	3/8	
	PD83	1/8	
	PD43	1/4	
	PD33	3/8	

A richiesta: tipi prolungati-spaziati.

PD	RACCORDO -1633-		
	COD. ART.	MISURA	PREZZO
	PD88	1/8	

RA RN RR	RANELLA -2651- allum. -2661- nylon		
	COD. ART.	MISURA	PREZZO
	RA8	1/8 allum.	
	RA4	1/4 allum.	
	RA3	3/8 allum.	
	RA2	1/2 allum.	
	RN5	M5 nylon	
	RN8	1/8 nylon	
	RN4	1/4 nylon	
	RN3	3/8 nylon	
	RN2	1/2 nylon	
	RR8	1/8 rame	
	RR4	1/4 rame	
	RR3	3/8 rame	
	RR2	1/2 rame	

AN	RACCORDO -1050-			
	COD. ART.	MISURA	Conf.	PREZZO
 CONICO	AN48	4-1/8	100	
	AN68	6-1/8	100	
	AN64	6-1/4	100	
	AN88	8-1/8	100	
	AN84	8-1/4	100	
	AN83	8-3/8	100	
	AN104	10-1/4	50	
	AN103	10-3/8	50	
	AN102	10-1/2	50	
	AN124	12-1/4	50	
	AN123	12-3/8	25	
	AN122	12-1/2	25	

CN	RACCORDO -1020-			
	COD. ART.	MISURA	Conf.	PREZZO
 CONICO	CN48	4-1/8	100	
	CN68	6-1/8	100	
	CN64	6-1/4	100	
	CN88	8-1/8	100	
	CN84	8-1/4	100	
	CN83	8-3/8	50	
	CN104	10-1/4	50	
	CN103	10-3/8	50	
	CN102	10-1/2	25	
	CN124	12-1/4	25	
	CN123	12-3/8	25	
	CN122	12-1/2	25	

PT	RACCORDO -1000-				
	COD. ART.	MISURA	Conf.	PREZZO	
 CONICO	PT48	4-1/8	50		
	PT68	6-1/8	50		
	PT64	6-1/4	50		
	PT88	8-1/8	50		
	PT84	8-1/4	50		
	PT104	10-1/4	25		
	PT103	10-3/8	25		
	PT123	12-3/8	20		
	PT122	12-1/2	20		

AR	RACCORDO -1051-			
	COD. ART.	MISURA	Conf.	PREZZO
 CILINDRICO	AR48	4-1/8	50	
	AR68	6-1/8	50	
	AR64	6-1/4	50	
	AR88	8-1/8	50	
	AR84	8-1/4	50	
	AR83	8-3/8	50	
	AR104	10-1/4	25	
	AR103	10-3/8	25	

CR	RACCORDO -1170-			
	COD. ART.	MISURA	Conf.	PREZZO
 CONICO	CR68	6-1/8	50	
	CR64	6-1/4	50	
	CR88	8-1/8	50	

PV	RACCORDO -1010-				
	COD. ART.	MISURA	Conf.	PREZZO	
 CONICO	PV48	4-1/8	50		
	PV68	6-1/8	50		
	PV64	6-1/4	50		
	PV88	8-1/8	50		
	PV84	8-1/4	50		
	PV104	10-1/4	25		
	PV103	10-3/8	25		
	PV123	12-3/8	20		
	PV122	12-1/2	20		

AQ	RACCORDO -1063-			
	COD. ART.	MISURA	Conf.	PREZZO
 CONICO	AQ48	4-1/8	50	
	AQ68	6-1/8	50	
	AQ64	6-1/4	50	
	AQ88	8-1/8	50	
	AQ84	8-1/4	50	

CH	RACCORDO -1093-			
	COD. ART.	MISURA	Conf.	PREZZO
 CONICO	CH48	4-1/8	50	
	CH68	6-1/8	50	
	CH64	6-1/4	50	
	CH88	8-1/8	50	
	CH84	8-1/4	50	

PT	RACCORDO -1210-			
	COD. ART.	MISURA	Conf.	PREZZO
 CONICO	PT04	4 mm	50	
	PT06	6 mm	50	
	PT08	8 mm	25	
	PT10	1 mm	25	
	PT12	12 mm	10	

AN	RACCORDO -1230-			
	COD. ART.	MISURA	Conf.	PREZZO
 CONICO	AN04	4 mm	50	
	AN06	6 mm	50	
	AN08	8 mm	50	
	AN10	10 mm	25	
	AN12	12 mm	25	

CN	RACCORDO -1120-			
	COD. ART.	MISURA	Conf.	PREZZO
 CONICO	CN04	4 mm	50	
	CN06	6 mm	50	
	CN08	8 mm	50	
	CN10	10 mm	25	
	CN12	12 mm	25	

RE	RACCORDO -1200-			
	COD. ART.	MISURA	Conf.	PREZZO
 CONICO	RE04	4 mm	25	
	RE06	6 mm	25	
	RE08	8 mm	25	
	RE10	10 mm	20	

AP	RACCORDO -1250-			
	COD. ART.	MISURA	Conf.	PREZZO
 CONICO	AP04	4 mm	50	
	AP06	6 mm	50	
	AP08	8 mm	50	
	AP10	10 mm	25	

SO	OGIVA -1310-			
	COD. ART.	MISURA	Conf.	PREZZO
 CONICO	SO04	4 mm	100	
	SO06	6 mm	100	
	SO08	8 mm	100	
	SO10	10 mm	100	
	SO12	12 mm	100	

SI	RINFORZO -1320-			
	COD. ART.	MISURA	Conf.	PREZZO
 CONICO	SI04	4 mm	250	
	SI06	6 mm	250	
	SI08	8 mm	250	
	SI10	10 mm	100	
	SI15	15 mm	50	

RACCORDI IN OT. NATURALE PER IMPIANTI FISSI DISTRIBUZIONE ARIA COMPRESSA
 ADATTI SIA PER TUBI IN RILSAN CHE PER TUBI METALLICI

RED	RACCORDO CILINDR. -302-			
	COD. ART.	MISURA	Conf.	PREZZO
 CONICO	RED182	18-1/2	10	
	RED227	22-3/4	10	

REL	RACCORDO CILINDR. -402-			
	COD. ART.	MISURA	Conf.	PREZZO
 CONICO	REL182	18-1/2	10	
	REL227	22-3/4	10	

RIT	RACCORDO EQ -601-			
	COD. ART.	MISURA	Conf.	PREZZO
 CONICO	RIT18	18 mm	10	
	RIT22	22 mm	10	

RID	RACCORDO -301-			
	COD. ART.	MISURA	Conf.	PREZZO
 CONICO	RID18	18 mm	10	
	RID22	22 mm	10	

RIL	RACCORDO -401-			
	COD. ART.	MISURA	Conf.	PREZZO
 CONICO	RIL18	18 mm	10	
	RIL22	22 mm	10	

ROC	RIDUZIONE -68-			
	COD. ART.	MISURA	Conf.	PREZZO
 CONICO	ROC812	18-12	10	
	ROC815	18-15	10	
	ROC212	22-12	10	
	ROC215	22-15	10	

ROL	RACCORDO -403W-			
	COD. ART.	MISURA	Conf.	PREZZO
 CONICO	ROL122	12-1/2	10	
	ROL142	14-1/2	10	
	ROL152	15-1/2	10	
	ROL182	18-1/2	10	

* Questi raccordi sono fornibili per tubi da:
 6-8-10-12-14-16-18-20-22-28-35.
 * Le filettature vanno da 1/8 a 1"-1/4.
 * Ci sono altre filettature per i tipi illustrati oltre a quelle riportate.
 * Fornibili anche raccordi diritti-curvi-"T" con filettatura femmina.
 * A richiesta bussole rinforzo per tubi rilsan.

ORE	OGIVA OTTONE -65-			
	COD. ART.	MISURA	Conf.	PREZZO
 CONICO	ORE12	12 mm	10	
	ORE14	14 mm	10	
	ORE15	15 mm	10	
	ORE18	18 mm	10	
	ORE22	22 mm	10	

RACCORDI AD OGIVA

2-97

RACCORDO TIPO RED

RED

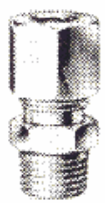

COD. ART.	MISURA	Acciaio M.P. brunito	Acciaio A.P. tropical.	Acciaio Inox	Ottone naturale
RED048	4-1/8				
RED068	6-1/8				
RED064	6-1/4				
RED088	8-1/8				
RED084	8-1/4				
RED083	8-3/8				
RED104	10-1/4				
RED103	10-3/8				
RED102	10-1/2				
RED123	12-3/8				
RED122	12-1/2				

M.P. = media pressione A.P. = alta pressione

RACCORDO TIPO REL

REL

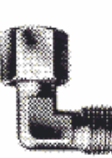

COD. ART.	MISURA	Acciaio M.P. brunito	Acciaio A.P. tropical.	Acciaio Inox	Ottone naturale
REL048	4-1/8				
REL068	6-1/8				
REL064	6-1/4				
REL088	8-1/8				
REL084	8-1/4				
REL083	8-3/8				
REL104	10-1/4				
REL103	10-3/8				
REL102	10-1/2				
REL123	12-3/8				
REL122	12-1/2				

M.P. = media pressione A.P. = alta pressione

RACCORDO TIPO REDF

REF



COD. ART.	MISURA	Acciaio M.P. brunito	Acciaio A.P. tropical.	Acciaio Inox	Ottone naturale
REF048	4-1/8				
REF068	6-1/8				
REF088	8-1/8				
REF084	8-1/4				
REF104	10-1/4				
REF122	12-1/2				

M.P. = media pressione A.P. = alta pressione

RACCORDO TIPO RIL

RIL



COD. ART.	MISURA	Acciaio M.P. brunito	Acciaio A.P. tropical.	Acciaio Inox	Ottone naturale
RIL04	4 mm				
RIL06	6 mm				
RIL08	8 mm				
RIL10	10 mm				
RIL12	12 mm				

M.P. = media pressione A.P. = alta pressione

RACCORDO TIPO RID

RID



COD. ART.	MISURA	Acciaio M.P. brunito	Acciaio A.P. tropical.	Acciaio Inox	Ottone naturale
RID04	4 mm				
RID06	6 mm				
RID08	8 mm				
RID10	10 mm				
RID12	12 mm				

M.P. = media pressione A.P. = alta pressione

RACCORDO TIPO RET

RET



COD. ART.	MISURA	Acciaio M.P. brunito	Acciaio A.P. tropical.	Acciaio Inox	Ottone naturale
RET048	4-1/8				
RET068	6-1/8				
RET064	6-1/4				
RET088	8-1/8				
RET084	8-1/4				
RET104	10-1/4				
RET103	10-3/8				
RET123	12-3/8				

M.P. = media pressione A.P. = alta pressione

RACCORDO TIPO RIT

RIT



COD. ART.	MISURA	Acciaio M.P. brunito	Acciaio A.P. tropical.	Acciaio Inox	Ottone naturale
RIT04	4 mm				
RIT06	6 mm				
RIT08	8 mm				
RIT10	10 mm				
RIT12	12 mm				

M.P. = media pressione A.P. = alta pressione

RACCORDO TIPO RETI

RTI



COD. ART.	MISURA	Acciaio M.P. brunito	Acciaio A.P. tropical.	Acciaio Inox	Ottone naturale
RTI048	4-1/8				
RTI068	6-1/8				
RTI064	6-1/4				
RTI088	8-1/8				
RTI084	8-1/4				
RTI104	10-1/4				
RTI103	10-3/8				
RTI123	12-3/8				

M.P. = media pressione A.P. = alta pressione

OGIVA RICAMBIO TIPO ORED

ORE



COD. ART.	MISURA	Acciaio M.P. brunito	Acciaio A.P. tropical.	Acciaio Inox	Ottone naturale
ORE04	4 mm				
ORE06	6 mm				
ORE08	8 mm				
ORE10	10 mm				
ORE12	12 mm				
ORE15	15 mm				

La misura si intende interna.

RACCORDO TIPO RIX

RIX



COD. ART.	MISURA	Acciaio M.P. brunito	Acciaio A.P. tropical.	Acciaio Inox	Ottone naturale
RIX04	4 mm				
RIX06	6 mm				
RIX08	8 mm				
RIX10	10 mm				
RIX12	12 mm				

M.P. = media pressione A.P. = alta pressione

BUSSOLA DI RINFORZO PER TUBI RILSAN

OIT



COD. ART.	MISURA	Acciaio M.P. brunito	Acciaio A.P. tropical.	Acciaio Inox	Ottone naturale
OIT04	4 mm				
OIT06	6 mm				
OIT08	8 mm				
OIT10	10 mm				
OIT12	12 mm				

La misura si intende esterna.

- Nel modello in ottone naturale è prevista anche l'ogiva in teflon e la nichelatura, oppure la tenuta con anello gomma (O-RING).
- Fornibili anche raccordi curvi-"T" con filettatura femmina
- Questi raccordi sono fornibili anche per tubi da 15 a 35 mm.

RACCORDI - RUBINETTI - «COMP.»

2-97

RAB **RACCORDO BAIONETTA**

COD. ART.	MISURA	PREZZO
RAB4M	1/4	



RAB **RACCORDO BAIONETTA**

COD. ART.	MISURA	PREZZO
RAB8F	1/8	
RAB4F	1/4	
RAB3F	3/8	



RAB **RACCORDO BAIONETTA**

COD. ART.	MISURA	PREZZO
RAB14	6x14	
RAB17	8x17	
RAB19	10x19	
RAB23	13x23	

RAB23= raccordo serie gigante.



RUC **RUBINETTO A CORSOIO**

COD. ART.	MISURA	PREZZO
RUC14	6x14	
RUC17	8x17	



RAB **RACCORDO BAIONETTA**

COD. ART.	MISURA	PREZZO
RAB07	7 mm	
RAB09	9 mm	



RAB **RACCORDO BAIONETTA**

COD. ART.	MISURA	PREZZO
RAB06	6x4	
RAB08	8x6	
RAB10	10x8	
RAB12	12x10	



RUC **RUBINETTO A CORSOIO**

COD. ART.	MISURA	PREZZO
RUC08	8x6	
RUC10	10x8	



RAG **GUARNIZIONE**

COD. ART.	MISURA	PREZZO
RAGGG	13mm	

Guarnizione, ricambio per raccordi e rubinetti a baionetta.



RAB **RACCORDO BAIONETTA**

COD. ART.	MISURA	PREZZO
RAB8G	8x6	
RAB1G	10x8	

Testa Girevole



RAE **RACCORDO PORTAGOMMA**

COD. ART.	MISURA	PREZZO
RAE14	1/4 6x14	
RAE17	1/4 8x17	
RAE19	3/8 10x19	
RAE23	3/8 13x23 g.	
RAE23	1/2 13x23 g.	

A richiesta: filettature diverse.

RAE23= raccordo serie gigante.



RAE **RACCORDO TUBO RILSAN**

COD. ART.	MISURA	PREZZO
RAE06	1/8 6x4	
RAE08	1/4 8x6	
RAE10	1/4 10x8	
RAE12	3/8 12x10	

A richiesta: filettature diverse.



RAE **RACCORDO TUBO RILSAN**

COD. ART.	MISURA	PREZZO
RAE08G	1/4 8x6	
RAE10G	1/4 10x8	

Testa Girevole

A richiesta: filettature diverse.



RAI **RACCORDO PORTAGOMMA**

COD. ART.	MISURA	PREZZO
RAI14	1/4 6x14	
RAI17	1/4 8x17	

A richiesta: filettature diverse.



RAI **RACCORDO TUBO RILSAN**

COD. ART.	MISURA	PREZZO
RAI06	1/8 6x4	
RAI08	1/4 8x6	
RAI10	1/4 10x8	
RAI12	3/8 12x10	

A richiesta: filettature diverse.



RAF **RACCORDO FRESATO**

COD. ART.	MISURA	PREZZO
RAF8M	1/8	
RAF4M	1/4	
RAF3M	3/8	
RAF3X	3/8 gigante	
RAF2X	1/2 gigante	



RAF **RACCORDO FRESATO**

COD. ART.	MISURA	PREZZO
RAF4F	1/4	
RAF3F	3/8	



RAF **RACCORDO FRESATO**

COD. ART.	MISURA	PREZZO
RAFDD		
RAFXD	Gigante	



RAF **RACCORDO FRESATO**

COD. ART.	MISURA	PREZZO
RAFTT		



RUC **RUBINETTO A CORSOIO**

COD. ART.	MISURA	PREZZO
RUC4M	1/4	
RUC3M	3/8	



RAF **DADO FRESATO**

COD. ART.	MISURA	PREZZO
RAFF	1/4	
RAFF	14x1,25	
RAFF	3/8	
RAFXX	1/2 Gigante	



RUV **RUBINETTO A SPILLO**

COD. ART.	MISURA	PREZZO
RUV8M*	1/8	
RUV4M	1/4	
RUV3M	3/8	
RUV2M	1/2	

*con galletto anziché manopola



REX **RACCORDO GIGANTE EXPRESS**

COD. ART.	MISURA	PREZZO
REX2M	1/2	
REX7M	3/4	
REX1M	1"	
REX00	guam. ric.	



REX **RACCORDO GIGANTE EXPRESS**

COD. ART.	MISURA	PREZZO
REX2F	1/2	
REX7F	3/4	
REX1F	1"	
REX00	guam. ric.	



REX **RACCORDO GIGANTE EXPRESS**

COD. ART.	MISURA	PREZZO
REX13	13 mm	
REX16	16 mm	
REX19	19 mm	
REX00	guam. ric.	



INNESTI E RUBINETTI RAPIDI

2-97

DIAMETRO NOMINALE 5,5 MM

serie Italia

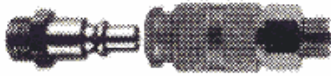

PRESSIONE ESERCIZIO MAX 12 BAR

RAR	INNESTO RAPIDO -ITALIA-	COD. ART.	MISURA	PREZZO
	RAR8M		1/8	
	RAR4M		1/4	
	RAR3M		3/8	
	RARX3M		3/8 gigante	
	RARX2M		1/2 gigante	

RAR	INNESTO RAPIDO -ITALIA-	COD. ART.	MISURA	PREZZO
	RAR8F		1/8	
	RAR4F		1/4	
	RAR3F		3/8	

RAR	INNESTO RAPIDO -ITALIA-	COD. ART.	MISURA	PREZZO
	RAR14		6x14	
	RAR17		8x17	
	RAR19		10x19	
	RARX23		13x23 gig.	

RAR	INNESTO RAPIDO -ITALIA-	COD. ART.	MISURA	PREZZO
	RAR07		7 mm	
	RAR09		9 mm	

RAR	INNESTO RAPIDO -ITALIA-	COD. ART.	MISURA	PREZZO
	RAR06		6x4	
	RAR08		8x6	
	RAR10		10x8	
	RAR12		12x10	

RAR	INNESTO RAPIDO BAIONETTA	COD. ART.	MISURA	PREZZO
	RARBB		Italia	

SMC CONNETTORE MULTIPLO -DM-

PER TUBI POLIURETANO/RILSAN DIAMETRO 4-6 MM
NUMERO TUBI 6-12

RURN

RUBINETTO RAPIDO -ITALIA GERMANIA-	COD. ART.	MISURA	PREZZO
RURN4M		1/4	
RURN3M		3/8	
RURN2M		1/2	
RURN4F		1/4 F	
RURN3F		3/8 F	

RUR	RUBINETTO RAPIDO -ITALIA-	COD. ART.	MISURA	PREZZO
	RUR4M		1/4	
	RUR3M		3/8	
	RUR2M		1/2	
	RURX3M		3/8 gigante	
	RURX2M		1/2 gigante	

RUR	RUBINETTO RAPIDO -ITALIA-	COD. ART.	MISURA	PREZZO
	RUR4F		1/4	
	RUR3F		3/8	
	RURX2F		1/2 gigante	

RUR	RUBINETTO RAPIDO -ITALIA-	COD. ART.	MISURA	PREZZO
	RUR14		6x14	
	RUR17		8x17	
	RURX23		13x23 gig.	

RUR	RUBINETTO RAPIDO -ITALIA-	COD. ART.	MISURA	PREZZO
	RUR07		7 mm	
	RUR09		9 mm	

RUR	RUBINETTO RAPIDO -ITALIA-	COD. ART.	MISURA	PREZZO
	RUR08		8x6	
	RUR10		10x8	

DIAMETRO NOMINALE 7,5 MM

serie Japan

MODELLI COMPATIBILI CON LA SERIE JAPAN

MODELLI PER OLEODINAMICA

serie Standard

CON RITEGNO ANCHE SULL'INNESTO



DIAMETRO NOMINALE 5 MM

serie mini



PRESSIONE ESERCIZIO MAX 12 BAR
ADATTI ANCHE PER ACQUA

RAR - A	INNESTO RAPIDO MINI - 5150	COD. ART.	MISURA	PREZZO
	RARA8M		1/8	
	RARA4M		1/4	

RAR - A	INNESTO RAPIDO MINI - 5350	COD. ART.	MISURA	PREZZO
	RARA8F		1/8	
	RARA4F		1/4	

RAR - A	INNESTO RAPIDO MINI - 5750	COD. ART.	MISURA	PREZZO
	RARA14		6x14	
	RARA17		8x17	

RAR - A	INNESTO RAPIDO MINI - 5850	COD. ART.	MISURA	PREZZO
	RARA06		6x4	
	RARA08		8x6	

RAR - A	INNESTO RAPIDO MINI - 5450	COD. ART.	MISURA	PREZZO
	RARA64		6x4	
	RARA86		8x6	

RAR - A	INNESTO RAPIDO MINI - 5650	COD. ART.	MISURA	PREZZO
	RARA07		6 mm	
	RARA09		9 mm	

RAR - A	INNESTO RAPIDO BAIONETTA	COD. ART.	MISURA	PREZZO
	RARABB			

RUR - A
RUBINETTO RAP. MINI - 5051

COD. ART. MISURA PREZZO

 RURA8M 1/8
 RURA4M 1/4

mini

DIAMETRO NOMINALE 8 MM

serie Germania



PRESSIONE DI ESERCIZIO MAX 12 BAR

RUR - B
RUBINETTO TEDESCO -5081-

COD. ART. MISURA PREZZO

 RURB4M 1/4
 RURB3M 3/8
 RURB2M 1/2
 RURC4M* 1/4
 RURC3M* 3/8
 RURC2M* 1/2

* Modelli CEJN (Svezia) - Press. max 35 bar

RUR - A
RUBINETTO RAP. MINI - 5053

COD. ART. MISURA PREZZO

 RURA8F 1/8
 RURA4F 1/4

mini

RAR - B
INNESTO TEDESCO -5180-

COD. ART. MISURA PREZZO

 RARB4M 1/4
 RARB3M 3/8
 RARB2M 1/2

RUR - B
RUBINETTO TEDESCO -5083-

COD. ART. MISURA PREZZO

 RURB4F 1/4
 RURB3F 3/8
 RURB2F 1/2
 RURC4F* 1/4
 RURC3F* 3/8
 RURC2F* 1/2

* Modelli CEJN (Svezia) - Press. max 35 bar

RUR - A
RUBINETTO RAP. MINI - 5057

COD. ART. MISURA PREZZO

 RURA14 6x14
 RURA17 8x17

mini

RAR - B
INNESTO TEDESCO -5380-

COD. ART. MISURA PREZZO

 RARB4F 1/4
 RARB3F 3/8
 RARB2F 1/2

RUR - B
RUBINETTO TEDESCO -5087-

COD. ART. MISURA PREZZO

 RURB14 6x14
 RURB17 8x17
 RURB19 10x19
 RURB23 13x23

RUR - A
RUBINETTO RAP. MINI - 5058

COD. ART. MISURA PREZZO

 RURA06 6x4
 RURA08 8x6

mini

RAR - B
INNESTO TEDESCO -5780-

COD. ART. MISURA PREZZO

 RARB14 6x14
 RARB17 8x17
 RARB19 10x19
 RARB23 13x23

RUR - B
RUBINETTO TEDESCO -5088-

COD. ART. MISURA PREZZO

 RURB08 8x6
 RURB10 10x8

RUR - A
RUBINETTO RAP. MINI - 5054

COD. ART. MISURA PREZZO

 RURA64 6x4
 RURA84 8x6

mini

RAR - B
INNESTO TEDESCO -5880-

COD. ART. MISURA PREZZO

 RARB08 8x6
 RARB10 10x8

RUR - B
RUBINETTO TEDESCO -5084-

COD. ART. MISURA PREZZO

 RURB86 8x6
 RURB18 10x8

RUR - A
RUBINETTO RAP. MINI - 5055

COD. ART. MISURA PREZZO

 RURA6P 6x4
 RURA8P 8x6

mini

RAR - B
INNESTO TEDESCO -5480-

COD. ART. MISURA PREZZO

 RARB86 8x6
 RARB108 10x8

RUR - B
RUBINETTO TEDESCO -5085-

COD. ART. MISURA PREZZO

 RURB8P 8x6
 RURB1P 10x8

RUR - A
RUBINETTO RAP. MINI - 5052

COD. ART. MISURA PREZZO

 RURA88 1/8
 RURA44 1/4

mini

RAR - B
INNESTO TEDESCO -5680-

COD. ART. MISURA PREZZO

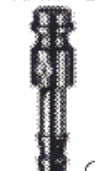
 RARB06 6 mm
 RARB09 9 mm
 RARB12 12 mm

RUR - B
RUBINETTO TEDESCO -5082-

COD. ART. MISURA PREZZO

RURB4P 1/4

RUR - A
RUBINETTO RAP. MINI - 5056

COD. ART. MISURA PREZZO

 RURA07 6 mm
 RURA09 9 mm

mini

RAR - B
INNESTO TEDESCO / BAIONETTA

COD. ART. MISURA PREZZO

RARBG Germania

RUR - B
RUBINETTO TEDESCO -5086-

COD. ART. MISURA PREZZO

 RURB06 6 mm
 RURB09 9 mm
 RURB12 12 mm
 RURC06* 6 mm
 RURC09* 9 mm
 RURC12* 12 mm

* Modelli CEJN (Svezia) - Press. max 35 bar

TRI TUBO RILSAN - PA11 -

COD. ART.	MISURA	PREZZO
TRI03	3x1,5	
TRI04	4x2,5	
TRI24	4x2	
TRI05	5x3	
TRI06	6x4	
TRI08	8x6	
TRI10	10x8	
TRI12	12x10	
TRI14	14x12	
TRI15	15x12	
TRI12	12x10 a.e.	
TRI18	18x15 a.e.	
TRI22	22x18 a.e.	

Confezioni dal diametro 3 a 8 mt 100 dal 10 al 18 mt 50

Disponibilità colori: neutro, verde, blu, rosso, giallo, arancio, nero, ecc.

media flessibilità

TS TUBO SPIRALE RILSAN - PA11 -

COD. ART.	MISURA	PREZZO
TS410	4x10 mt	
TS420	4x20 mt	
TS610	6x10mt	
TS620	6x20 mt	
TS810	8x10 mt	
TS820	8x20 mt	
TS830	8x30 mt	
TS110	10x10 mt	
TS120	10x20 mt	
TS130	10x30 mt	
TS210	12x10 mt	
TS220	12x20 mt	
TS510	15x10 mt	
TS520	15x20 mt	

A richiesta con codoli terminali. Disponibilità colori come TRI

media flessibilità

TRA TUBO RAME RICOTTO

COD. ART.	MISURA	PREZZO
TRA43	4x3	
TRA04	4x2	
TRA06	6x4	
TRA08	8x6	
TRA10	10x8	
TRA12	12x10	

Caratteristiche tecniche

MISURA	Gr. per Mt.	Press. eserc.
4x3	0,049	133
4x2	0,084	214
6x4	0,140	200
8x6	0,195	130
10x8	0,251	100
12x10	0,308	80

Idoneo per impianti di lubrificazione e per alte temperature

TRX TUBO RILSAN MORBIDO

COD. ART.	MISURA	PREZZO
TRX04	4x2,5	
TRX06	6x4	
TRX08	8x6	

Confezioni da 4 a 8 mt 100, da 10 mt 50

medio-alta flessibilità

TSH TUBO SPIRALE HTR

COD. ART.	MISURA	PREZZO
TSH610	6x10 mt.	
TSH620	6x20 mt.	
TSH810	8x10 mt.	
TSH815	8x15 mt.	
TSH820	8x20 mt.	
TSH830	8x30 mt.	

Colori disponibili: azzurro e arancio.

media flessibilità

TAC TUBO ACCIAIO

COD. ART.	MISURA	PREZZO
TAC04	4	
TAC06	6	
TAC08	8	
TAC10	10	

Idoneo per impianti oleodinamici.

TRR TUBO RILSAN RIGIDO

COD. ART.	MISURA	PREZZO
TRR04	4x2,5	
TRR06	6x4	
TRR08	8x6	
TRR10	10x8	
TRR12	12x10	

Confezioni da 4 a 8 mt 100, da 10 mt 50

bassa flessibilità

TGO TUBO GOMMA 20 BAR

COD. ART.	MISURA	PREZZO
TGO12	6x12	
TGO14	6x14	
TGO17	8x17	
TGO19	10x19	
TGO23	13x23	

Confezione mt 100

TAP TUBO ALTA PRESS. OLIO

COD. ART.	MISURA	PREZZO
TAP08	8x4-OL5	
TAP11	3/16-R8	
TAP12	1/4-R7	
TAP13	1/4-R8	
TAP16	3/8-R7	

Idoneo per impianti oleodinamici.

TPO TUBO POLIETILENE - PE -

COD. ART.	MISURA	PREZZO
TPO04	4x2,5	
TPO06	6x4	
TPO08	8x6	
TPO10	10x8	

Adatto per liquidi a base di cloro. Confezioni da 4 a 8 mt 100, da 10 mt 50

idoneo per alimenti

TPU TUBO POLIURET. RET. 15 BAR

COD. ART.	MISURA	PREZZO
TPU10	6x10 100 mt	
TPU12	8x12 60 mt	
TPU15	10x15 50 mt	
TPU19	13x19 30 mt	
TPU23	16x23 25 mt	

Colore verde. Confezione scatola cartone

alta flessibilità

TUS TUBO SILICONE

COD. ART.	MISURA	PREZZO
TUS06	4X6	
TUS09	6X9	
TUS10	5X10	
TUS11	6X11	
TUS12	7X12	
TUS14	8X14	

Adatto per temperature fino 150°

alta flessibilità

TEX TUBO POLIURETANO FLEX

COD. ART.	MISURA	PREZZO
TEX04	4x2,5	
TEX06	6x4	
TEX08	8x6	
TEX10	10x8	

Colore azzurro. A richiesta: 90 o 98 shore. Confezioni da 4 a 8 mt 100, da 10 mt 50

alta flessibilità

TRE TUBO RAGNO PVC RETINATO

COD. ART.	MISURA	PREZZO
TRE12	6x12	
TRE14	8x14	
TRE15	9x15	
TRE16	10x16	
TRE19	13x19	
TRE22	16x22	
TRE26	19x26	
TRE33	25x33	

Idoneo per alimenti (v.tab. TAS)

TEF P.T.F.E.

COD. ART.	MISURA	PREZZO
TEF04	4x2	
TEF06	6x4	
TEF08	8x6	
TEF10	10x8	

Adatto per temperature fino 250° Confezione mt 100

bassa flessibilità

TPV TUBO PVC TELATO FLEX

COD. ART.	MISURA	PREZZO
TPV06	6x4	
TPV08	8x6	
TPV10	10x8	

Colore azzurro. Confezione mt 50

medio-alta flessibilità

TAS TUBO PVC PER ASPIRAZIONE

COD. ART.	MISURA	PREZZO
TAS10	int. 10 mm	
TAS12	int. 12 mm	
TAS14	int. 14 mm	
TAS16	int. 16 mm	
TAS18	int. 18 mm	
TAS20	int. 20 mm	
TAS22	int. 22 mm	
TAS25	int. 25 mm	
TAS30	int. 30 mm	
TAS32	int. 32 mm	
TAS35	int. 35 mm	
TAS38	int. 38 mm	
TAS40	int. 40 mm	
TAS45	int. 45 mm	
TAS50	int. 50 mm	

Idoneo per alimenti del tipo Ia-Ib-IVa-IVb secondo D.M. 4/4/85 e Dir. CEE

TAV TUBO ANTIVIBRANTE 500 mm.

COD. ART.	MISURA	PREZZO
TAV38	3/8	
TAV12	1/2	
TAV34	3/4	
TAV01	1"	
TAV05	1" 1/4	
TAV06	1" 1/2	
TAV02	2"	

TCR TUBO PVC CRISTALLO ATOSS.

COD. A.	MISURA	Gr.-Mt.	PREZZO
TCR53	3x5	15	
TCR74	4x7	32	
TCR85	5x8	40	
TCR96	6x9	45	
TCR17	7x10	52	
TCR12	8x12	78	
TCR22	16x22	225	

alta flessibilità

ARR AVVOLGITUBO ARIA

COD. ART.	MISURA	PREZZO
ARR1	diam. foro 6 mt 7,5+1,5	
ARR2	diam. foro 8 mt 10+2	
ARR3	diam. foro 10 mt 15+2	

FASCETTE - ACCESSORI E UTENSILI PER TUBI, ecc.

9-97

FAA FASCETTA STRINGITUBO STANDARD

COD. ART.	MISURA	nastro	PREZZO
FAA15	8-12	9	
FAA17	10-16	9	
FAA22	12-20	9	
FAA25	16-25	9	
FAA32	20-32	9	
FAA40	25-40	9	

ABA NOVA  **S**
Nastro ALUZINC - Carter verniciato blu.

FAS FASCETTA STRINGITUBO

COD. ART.	MISURA	nastro	PREZZO
FAS15	8-14	9	
FAS17	11-17	9	
FAS22	13-20	9	
FAS25	15-24	9	
FAS28	19-28	12,2	
FAS32	22-32	12,2	
FAS38	26-38	12,2	
FAS44	32-44	12,2	
FAS50	38-50	12,2	
FAS56	44-56	12,2	
FAS65	50-65	12,2	
FAS75	58-75	12,2	
FAS85	68-85	12,2	
FAS95	77-95	12,2	

ABA ORIGINALE  **EXTRA** **S**
Nastro ALUZINC - Carter verniciato blu.
Confezioni: fino FAS38 scatola plastica
44-56/50-65 busta, oltre sfuse con leg.

FAN FASCETTA NYLON

COD. ART.	MISURA	PREZZO
FAN140	3,6x140	
FAN160	4,5x160	
FAN200	4,8x200	
FAN290	4,8x290	
FAN360	4,8x360	
FAN450	7,8x450	

D Confezioni in busta plastica da 100 pezzi

TT TRONCHESA TAGLIATUBO

COD. ART.	MISURA	PREZZO
TT1	130 mm	
TT2	180 mm	
TT3	lama TT1	
TT4	lama TT2	

I TT1 taglio fino 15 mm diametro
TT2 taglio fino 23 mm diametro

MPL MORSETTIERA FERMATUBO

COD. ART.	MISURA	PREZZO
MPL04	4mm	
MPL06	6mm	
MPL08	8mm	
MPL10	10mm	
MPL12	12mm	
MPL15	15mm	

Con 5 posizioni

COD. ART.	MISURA	PREZZO
MPL041	4mm	
MPL061	6mm	
MPL081	8mm	
MPL101	10mm	
MPL121	12mm	
MPL151	15mm	

Con 1 posizione

NAS NASTRO ISOLANTE

COD. ART.	MISURA	PREZZO
NAS		

I

FAT FASCETTA STRINGITUBO STANDARD

COD. ART.	MISURA	nastro	PREZZO
FAT12	9-12	9	
FAT16	11-16	9	
FAT20	13-20	9	
FAT22	16-22	12	
FAT25	18-25	12	
FAT30	22-30	12	
FAT35	25-35	12	
FAT40	30-40	12	
FAT50	35-50	12	
FAT55	40-55	12	
FAT60	45-60	12	
FAT70	55-70	12	
FAT80	60-80	12	
FAT90	70-90	12	
FAT100	85-100	12	

TERRY  **GB**
Materiale: Acciaio al carbonio rivestito in ALUZINC - Coppia di serraggio sup. 6 Nm

FAX FASCETTA STRINGITUBO INOX

COD. ART.	MISURA	nastro	PREZZO
FAX16	5,6-16	8	
FAX20	11-20	8	
FAX27	14-27	12,7	
FAX32	17-32	12,7	
FAX38	21-38	12,7	
FAX45	30-45	12,7	

BREEZE USA  **I**
Materiale: Acciaio AISI 300 vite zincata

FXX FASCETTA STRINGITUBO INOX

COD. ART.	MISURA	nastro	PREZZO
FXX20	11-20	12,7	
FXX23	13-23	12,7	
FXX27	14-27	12,7	
FXX32	17-32	12,7	
FXX38	21-38	12,7	

BREEZE USA  **I**
Coppia di serraggio: 11 Nm
Materiale: Acciaio AISI 304 vite zincata

TTR TAGLIATUBI RAME

COD. ART.	MISURA	PREZZO
TTR1	58 mm	

D Per tubi rame fino a 16 mm di diametro

TTR TAGLIATUBI RAME

COD. ART.	MISURA	PREZZO
TTR2	155 mm	

D Per tubi rame fino a 32 mm di diametro

PTFE NASTRO TEFLON

COD. ART.	MISURA	PREZZO
PTFE	rotolo sing.	
PTFE10	conf. 10 pz.	

I

PTF FRENAFILETTI

COD. ART.	MISURA	PREZZO
PTFL	50 ml	
PTFM	50 ml	

I PTFL pasta al P.T.F.E. bassa resist. smontagg.
PTFM liquido con media resist. smontagg.

FAV FASCETTA STRINGITUBO MINI

COD. ART.	MISURA	PREZZO
FAV08	6-8,3	
FAV09	7-9,3	
FAV10	8-10,3	
FAV11	9-11,3	
FAV12	10-12,3	
FAV13	11-13,3	
FAV14	12-14,3	
FAV15	13-15,3	
FAV16	14-16,3	
FAV17	15-17,3	

S Confezione sacchetto plastica 100 pezzi
Larghezza nastro 9mm
Esagono vite 7mm

FAO FASCETTA A TENAGLIA

COD. ART.	MISURA	PREZZO
FAO09	7-9	
FAO11	9-11	
FAO12	10-12	
FAO13	11-13	
FAO15	13-15	
FAO18	15-18	

I Confezioni in busta plastica da 100 pezzi

FAG FASCETTA GOMMATA

COD. ART.	MISURA	PREZZO
FAG06	6 mm	
FAG08	8 mm	
FAG10	10 mm	
FAG12	12 mm	
FAG14	14 mm	
FAG16	16 mm	
FAG18	18 mm	

D

FOR1 FORBICE DRITTA

COD. ART.	MISURA	PREZZO
FOR1	145 mm	

D

FOR2 FORBICE CESOIA INOX

COD. ART.	MISURA	PREZZO
FOR2	190 mm	

D

FOR3 CESOIA INOX PER CAVI EL.

COD. ART.	MISURA	PREZZO
FOR3	165 mm	

D Per cavi diametro 12 mm

BOMBOLETTE SPRAY

COD. ART.	MISURA	PREZZO
SBLOC	sbloccante	
SLUBE	grasso spray	
ROCUT	olio da taglio	
ZINCO	zincatura	

Bombolette da 400 ml
Altre versioni a richiesta.

PISTOLE - AEROGRAFI

9-97

PISTOLA SOFFIAGGIO ARIA - APERTURA REGOLABILE

PAB

COD. ART.	PREZZO
PAB	
PA9 prolunga ugello	



① Completa di ugello silenziato

PISTOLA SOFFIAGGIO ARIA - APERTURA REGOLABILE

PAV

COD. ART.	PREZZO
PAV	
vedi figura	
PAVI ugello lungo diritto 100 mm	
PAVL ugello lungo pieg. 100 mm	



① **VESSEL**

PISTOLA SOFFIAGGIO ARIA - APERTURA REGOLABILE

PAJ

PAJS: conforme D.M. 277 sull'inquinamento acustico

COD. ART.	PREZZO
PAJ	
PAJS*	
PAJL°	



① **CEJN** ② *Modello silenziato
°Modello canna lunga mm 330

UGELLO SILENZIATORE PER PISTOLA -PAJ-

PA1

COD. ART.	PREZZO
PA1	

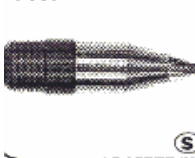

①

UGELLO GOMMA PER PISTOLA -PAJ-

PA2

COD. ART.	PREZZO
PA2	

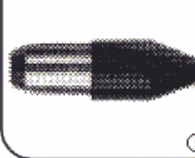

①

UGELLO "AUMENTA GETTO" PER PISTOLA -PAJ-

PA3

COD. ART.	PREZZO
PA3	



①

UGELLO BY-PASS + SCHERMO PROTETTIVO

PA4
PA5

per art. PAJ

COD. ART.	PREZZO
PA4	
by-pass	
PA5	
by pass + schermo protett.	

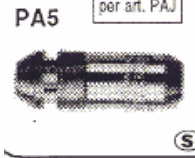

①

SCHERMO PROTETTIVO SINTETICO

PA6
PA7

COD. ART.	PREZZO
PA6	
ricambio per pistola PAJ	
PA7	
ricambio per pistola PAB	



①

PISTOLA SOFFIAGGIO ARIA -GOMMA-

PAG

COD. ART.	PREZZO
PAG	

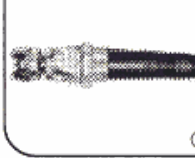

①

PISTOLA SOFFIAGGIO ARIA -MINI-

PAM

COD. ART.	PREZZO
PAM	
PA8*	



① *Ugello ricambio 1/8

PISTOLA SOFFIAGGIO ARIA -STANDARD-

PAN

COD. ART.	PREZZO
PAN	
PA8*	



① *Ugello ricambio 1/4

PISTOLA SOFFIAGGIO ARIA -LUNGA-

PAL

COD. ART.	PREZZO
PAL	
PA9*	



① *Ugello ricambio 1/4

MANOMETRO PROVA PRESSIONE

MPP

COD. ART.	PREZZO
MPP	



① Completo di testina "Michelin"

PISTOLA GONFIAGGIO

PGO

COD. ART.	PREZZO
PGO	
PG1*	
PG3°	



① *Manometro di ricambio con protezione gomma
°Solo protezione gomma

PISTOLA GONFIAGGIO

PGE

COD. ART.	PREZZO
PGE	
PG2*	
PG3°	



① **EXTRA** *Manometro di ricambio con protezione gomma
°Solo protezione gomma

TESTINA GONFIAGGIO -TIPO MICHELIN-

PG4

COD. ART.	PREZZO
PG4	

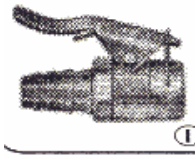

①

PISTOLA LAVAGGIO PER NAFTA It. 1

PNA

COD. ART.	PREZZO
PNA	



①

PISTOLA LAVAGGIO ARIA-ACQUA

PAA

COD. ART.	PREZZO
PAA	
PAAE*	



① *Modello ANI tipo extra

PISTOLA SABBIAATRICE

PSA

COD. ART.	PREZZO
PSA	
PSAA tipo grande	



①

ASPIRAPOLVERE CON ACCESSORI

PAS

COD. ART.	PREZZO
PAS	



① Nel kit è compreso anche sacchetto tela, tubo plastica spirata e bocchetta stretta

AEROGRAFO VERNICIATURA -AUTOMATICO-

AVA

COD. ART.	PREZZO
AVA	



① **AZIONAMENTO PNEUMATICO**

A richiesta: spruzzatura abrasiva liquido per smalti ceramici.

AEROGRAFO VERNICIATURA -MINI-

AVM

COD. ART.	PREZZO
AVM cc. 250	
serb. nylon, getto a rosa e ventaglio	
AVR cc. 250	
serb. alluminio, getto a rosa fisso	

Ugelli disponibili:
0,3-0,5-0,7-1

Serbatoi cc. 100-250



①

AEROGRAFO VERNICIATURA -SERB. NYLON-

AVS

COD. ART.	PREZZO
AVS	

Getto a rosa e ventaglio. Possibile usare serb. inferiore

Ugelli disponibili:
1,3-1,5-1,7-1,9-2,2-2,5

Serbatoio cc. 500

A richiesta: serbat. alluminio



① **Tre regolazioni**

AEROGRAFO VERNICIATURA

AVI

COD. ART.	PREZZO
AVI serb. norm.	
AVS serb. lava	

Getto a rosa e ventaglio. Possibile usare serb. superiore

Ugelli disponibili:
1,3-1,5-1,7-1,9-2,2-2,5

Serbatoio cc. 1000



① **Tre regolazioni**

COMPONENTI COMPRESSORE - VALVOLE UNIDIREZIONALI - PRESSOSTATI - SERBATOI

VS VALVOLA DI SICUREZZA

COD. ART.	MISURA	PREZZO
VS8	1/8	
VS4	1/4	
VS3	3/8	
VS2	1/2	
VS7	3/4	
VS1	1"	

 **I** Regolabili da 6 a 12 bar circa.

VST VALVOLA DI SICUREZZA TARATA

COD. ART.	MISURA	PREZZO
VS4T	1/4	
VS3T	3/8	
VS2T	1/2	
VS7T	3/4	
VS1T	1"	

 **I** Taratura: VS4T 8,5 bar • altre: 11 bar

130 VALVOLA DI MASSIMA

COD. ART.	MISURA	PREZZO
1302	1/4	

 **GB** Regolabile; pressioni da 0-7 bar.

VRC VALVOLA RITEGNO VERTICALE

COD. ART.	MISURA	PREZZO
VRC38	3/8F - 3/8M	
VRC23	1/2F - 3/8M	
VRC12	1/2F - 1/2M	
VRC34	3/4F - 3/4M	
VRC01	1"F - 1"F	

 **I**

VRO VALVOLA RITEGNO ORIZZONTALE

COD. ART.	MISURA	PREZZO
VRO3	3/8	
VRO2	1/2	

 **I** Fornite con filettature maschio-maschio
A richiesta: filettatura maschio-femmina

VRC TASSELLO VITON RICAMBIO

COD. ART.	MISURA	PREZZO
VRC15	15 mm	
VRC20	20 mm	
VRC26	26 mm	

 **I** Ricambi per valvole ritegno compressori.

VU VALVOLA UNIDIR. OTTONE

COD. ART.	MISURA	PREZZO
VU5	M5	
VU8	1/8	
VU4	1/4	
VU3	3/8	
VU2	1/2	

 **I** 1/8 disponibile anche maschio-femmina.

U VALVOLA UNIDIR. OTTONE

COD. ART.	MISURA	PREZZO
U8	1/8	
U4	1/4	
U4SM	1/4	
U2	1/2	

 **I** Modello Waircom
Esecuzione: corpo ottone.

VUO VALVOLA UNIDIR. OT. SENSIBILE

COD. ART.	MISURA	PREZZO
VUO3	3/8	
VUO2	1/2	
VUO7	3/4	
VUO1	1"	
VUO6	1" 1/2	
VUO9	2"	

 **F** Corpo ott. nat. - 3/8-1/2 tenuta in VITON.

VUX VALVOLA UNIDIR. INOX -304-

COD. ART.	MISURA	PREZZO
VUX4	1/4	
VUX3	3/8	
VUX2	1/2	
VUX7	3/4	
VUX1	1"	
VUX6	1" - 1/2	
VUX9	2"	

 **I**

VUY VALVOLA UNIDIR. POLIPROP.

COD. ART.	MISURA	PREZZO
VUY3	3/8	
VUY2	1/2	
VUY7	3/4	

 **F** Corpo in polipropilene. Tenuta in VITON.
Adatta per l'industria alimentare e chimica.

FTV VALVOLA UNIDIR. ALTA PRESSIONE

COD. ART.	MISURA	PREZZO
FTV4	1/4	
FTV3	3/8	
FTV2	1/2	
FTV7	3/4	
FTV1	1"	

 **I** Nella figura modello FT257/6.

PR PRESSOSTATO MINIATURIZZATO

COD. ART.	PRESS.	PREZZO
PR02A	0-2 N.A.	
PR10A	0-10 N.A.	
PR02C	0-2 N.C.	
PR10C	0-10 N.C.	
PR000	Cuffia gomma	

 **I** N.A.= normal. aperto • N.C.= normal. chiuso
A richiesta: pressioni superiori.

VR VUOTOSTATO MINIATURIZZATO

COD. ART.	VUOTO	PREZZO
VR02A	150-700 mmHg	
VR02C	150-700 mmHg	
PR000	Cuffia gomma	

 **I** VR02A= norm. aperto • VR02C= norm. chiuso
A richiesta: esecuzioni diverse.

PR PRESSOSTATO PER SOTTOBASE

COD. ART.	PRESS.	PREZZO
PRMAX	0-7 bar	
BAMAX	sottobase 1/8	

 **F** Modello a tre contatti (chiuso-aperto).

PR PRESSOSTATO TRIPOLARE

COD. ART.	MISURA	PREZZO
PRST0	1/4 - 1 via	
PRST4	1/4 - 4 vie	

 **I** Modello Stogermatic.
Adatto per motori fino HP 3.
Taratura: 7,5-10 bar regolabile.

PR PRESSOSTATO TRIPOLARE

COD. ART.	MISURA	PREZZO
PRSE1	1/4 - 1 via	
PRSE4	1/4 - 4 vie	

 **I** Taratura: 6-8 bar regolabile.
Serie economica Stogermatic.

PR PRESSOSTATO DIGITALE

COD. ART.	PRESS.	PREZZO
PRSMC		

 **J**

RUB VALVOLA SCARICO SERBATOIO

COD. ART.	MISURA	PREZZO
RUB8	1/8	
RUB4	1/4	
RUB3	3/8	
RUB2	1/2	

 **I**

RPM RUBINETTO PORTAMANOMETRO

COD. ART.	MISURA	PREZZO
RPM4	1/4M - 1/4F	

 **I**

FAC FILTRO ASPIRAZ. COMPRESSORE

COD. ART.	MISURA	PREZZO
FAC3	3/8	
FAC2	1/2	
FAC1	1"	

 **I** FAC2-FAC1= completi di supporto filettato.
Nella figura FAC3.

SERC SERBATOIO CON ACCESSORI

COD. ART.	MISURA	PREZZO
SERC55	5,5 lt	
SERC08	8 lt	
SERC10	10 lt	
SERC14	14 lt	
SERC20	20 lt	
SERC24	24 lt	

 **I** Esecuzione: verniciatura blu.

SER SERBATOIO USO POLMONE

COD. ART.	MISURA	PREZZO
SER01	1 lt	
SER02	2,5 lt	
SER05	5 lt	
SER07	7 lt	
SER12	12 lt	

 **I** A richiesta: staffa fissaggio.
Esecuzione: verniciatura blu.

SER SERBATOIO COMPRESSORE

COD. ART.	MISURA	PREZZO
SER10	10 lt	
SER15	15 lt	
SER25	25 lt	

 **I** Esecuzione: acciaio non verniciato.
A richiesta applicazione zampe.

SILENZIATORI - REGOLATORI - DECELERATORI - SCARICHI RAPIDI

7-97

SO SILENZIATORE OTTONE -2901-

COD. ART.	MISURA	PREZZO
SO8	1/8	
SO4	1/4	
SO3	3/8	
SO2	1/2	
SO7	3/4	
SO1	1"	



SB SILENZIATORE BRONZO -2921-

COD. ART.	MISURA	PREZZO
SB8	1/8	
SB4	1/4	
SB3	3/8	
SB2	1/2	
SB7	3/4	
SB1	1"	



SP SILENZIATORE OT./BRONZO -SEP-

COD. ART.	MISURA	PREZZO
SP5	M5	
SP8	1/8	
SP4	1/4	
SP3	3/8	
SP2	1/2	
SP7	3/4	
SP1	1"	



SV SILENZIATORE OT. DA INCASSO -SP-

COD. ART.	MISURA	PREZZO
SV8	1/8	
SV4	1/4	
SV3	3/8	
SV2	1/2	
SV7	3/4	
SV1	1"	



SN SILENZIATORE NYLON-FELTRO

COD. ART.	MISURA	PREZZO
SN8	1/8	
SN4	1/4	
SN3	3/8	
SN2	1/2	



SF SILENZIATORE CON RESINA FONO-ASS.

COD. ART.	MISURA	PREZZO
SF8	1/8	
SF4	1/4	
SF3	3/8	
SF2	1/2	



SS SILENZIATORE SMC -AN400-

COD. ART.	MISURA	PREZZO
SS2	1/2	
SS7	3/4	
SS1	1"	



AMC SILENZIATORE CON RECUPERO OLIO

COD. ART.	MISURA	PREZZO
AMC38	3/8	
AMC34	3/4	
AMC01	1"	
AMC09	1" 1/2	
AMC02	2"	



VSR VALVOLA DI SCARICO RAPIDO

COD. ART.	MISURA	PREZZO
VSR8	1/8	
VSR4	1/4	
VSR2	1/2	
VSRA	ricambio 1/8	
VSRB	ricambio 1/4	
VSRC	ricambio 1/2	

Applicazione: su cilindri pn.



RVD REGOLATORE A VITE

COD. ART.	MISURA	PREZZO
RVD88	1/8M-1/8F	
RVD48	1/4M-1/8F	

Applicazione: su scarico valvola



URS REGOLATORE SILENZIATO

COD. ART.	MISURA	PREZZO
URS83	1/8	
URS45	1/4	
URS37	3/8	
URS29	1/2	

Applicazione: su scarico valvola



SIR REGOLATORE A VITE UNIDIREZ.

COD. ART.	MISURA	PREZZO
SIR8	1/8	
SIR4	1/4	
SCO	solo reg 1/8	
SCO	solo reg 1/4	
2905	filtro 1/8	
2905	filtro 1/4	

Applicazione: su scarico valvola



SVU REGOLATORE A VITE UNID.

COD. ART.	MISURA	PREZZO
SVUM5	M5	
SVU18	1/8	
SVU14	1/4	

Accoppiabile con raccordi orientabili.
Applicazione: su uscita valvola.

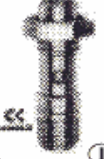

SCU REGOLATORE A VITE UNID.

COD. ART.	MISURA	PREZZO
SCUM5	M5	
SCU18	1/8	
SCU14	1/4	
SCU38	3/8	

Accoppiabile con raccordi orientabili.
Applicazione: su cilindri pn.



MCU REGOLATORE MANUALE UNID.

COD. ART.	MISURA	PREZZO
MCUM5	M5	
MCU18	1/8	
MCU14	1/4	
MCU38	3/8	

Accoppiabile con raccordi orientabili.
Applicazione: su cilindri pn.



URI REGOLATORE A VITE -S.P.-

COD. ART.	MISURA	PREZZO
URI48	4-1/8	
URI68	6-1/8	
URI64	6-1/4	
URI88	8-1/8	
URI84	8-1/4	

Applicazione: su cilindri pn.



GSC REGOLATORE MANUALE UNID.

COD. ART.	MISURA	PREZZO
GSC68	1/8 - 6 mm	
GSC88	1/8 - 8 mm	
GSC84	1/4 - 8 mm	
GSC104	1/4 - 10 mm	

A richiesta: bidirezionale.
Applicazione: su cilindri pn.



GMC REGOLATORE MANUALE UNID.

COD. ART.	MISURA	PREZZO
GMC68	1/8 - 6mm	
GMC88	1/8 - 8mm	
GMC84	1/4 - 8mm	
GMC104	1/4 - 10 mm	

A richiesta: bidirezionale.
Applicazione: su cilindri pn.



URU REGOLATORE MANUALE UNID.

COD. ART.	MISURA	PREZZO
URU8G	1/8	
URU4G	1/4	
URU3G	3/8	
URU2G	1/2	

A richiesta: bidirezionale.
Applicazione: su cilindri pn.



RFU REGOLATORE MANUALE UNID.

COD. ART.	MISURA	PREZZO
RFUM5	M5	
RFU18	1/8	
RFU14	1/4	

A richiesta: bidirezionale.
Applicazione: su cilindri pn.



URG REGOLATORE MANUALE UNID.

COD. ART.	MISURA	PREZZO
URG81	1/8-DN1	
URG82	1/8-DN2	
URG85	1/8-DN5	
URG41	1/4-DN10	
URG22	1/2-DN25	

A richiesta: bidirezionale.
Applicazione: su cilindri pn.



RBC DECELERATORE IDRAULICO

COD. ART.	MISURA	PREZZO
RBC0806	M8 x 1	
RBC1007	M10 x 1	
RBC1412	M14 x 1,5	
RBC2015	M20 x 1,5	
RBC2725	M27 x 1,5	

Completo di paracolpi in gomma.
Richiedere misure diverse.



RLE REGOLATORE IDRAULICO DI VELOCITA'

COD. ART.	MISURA	PREZZO
RLE.25.25	Ø25 corsa 25	
RLE.25.50	Ø25 corsa 50	
RLE.25.75	Ø25 corsa 75	

GF35 ghiera filettata
Adatto per regolare la velocità dei cilindri pneumatici.



REGOLATORE IDRAULICO DI VELOCITA'



Richiedere dati specifici

GRUPPI F.R.L. - TRATTAMENTO ARIA - ACQUA

QCF **FILTRO SEPARATORE SERIE -N-**

COD. ART.	MISURA	PREZZO
QCF08	1/8	
QCF04	1/4	

Scarico semi automatico e manuale.
A richiesta: tazza corta.
Esecuzione: ottone.



QCF **FILTRO SEPARATORE SERIE -C-**

COD. ART.	MISURA	PREZZO
QCF14	1/4	
QCF38	3/8	
QCF12	1/2	
QCF01	1" - gigante	

Scarico semi automatico e manuale.
Esecuzione: alluminio.



QSFAX **FILTRO PER ACQUA**

COD. ART.	MISURA	PREZZO
QSFAX	1/4	

Cartuccia acciaio inox-fine.
Plastica



QCFR **FILTRO RIDUTTORE SERIE -N-**

COD. ART.	MISURA	PREZZO
QCFR08	1/8	
QCFR04	1/4	

Scarico semi automatico e manuale.
A richiesta: tazza corta.
Esecuzione: ottone.



QCFR **FILTRO RIDUTTORE SERIE -C-**

COD. ART.	MISURA	PREZZO
QCFR14	1/4	
QCFR38	3/8	
QCFR12	1/2	
QCFR01	1" - gigante	

Scarico semi automatico e manuale.
Esecuzione: alluminio.



QDA **FILTRO PER ACQUA**

COD. ART.	MISURA	PREZZO
QDA38	3/8	
QDA12	1/2	
QDA34	3/4	

Esecuzione: ottone.
A richiesta: acciaio inox.



QCR **RIDUTTORE PRESSIONE SERIE -M-**

COD. ART.	MISURA	PREZZO
QCR08	1/8 0-10 bar	
QCR04	1/4 0-10 bar	
QCR8S	bar	
QCR4S	bar	
QCR8A	1/8 0-4 bar	
QCR4A	1/4 0-4 bar	

Esecuzione: ottone.



QCR **RIDUTTORE PRESSIONE SERIE -C-**

COD. ART.	MISURA	PREZZO
QCR14	1/4 0-10 bar	
QCR38	3/8 0-10 bar	
QCR12	1/2 0-10 bar	
QCR01	1" - gigante	

Esecuzione: alluminio.
A richiesta: modello con regolaz. 0-4 bar



QCRST **STAFFA FISSAGGIO RIDUTTORI SERIE -M-N-**

COD. ART.	MISURA	PREZZO
QCRST	foro 30 mm	

Adattabile a quasi tutti i riduttori mini.
Esecuzione: zincata.



QCR **RIDUTTORE PRESSIONE SERIE -N-**

COD. ART.	MISURA	PREZZO
QCR88	1/8 0-10 bar	
QCR44	1/4 0-10 bar	

A richiesta tipo 0-4 bar.
A richiesta tipo per acqua (no relieving).
Esecuzione: ottone.



QSR **RIDUTTORE PRESSIONE -ST-**

COD. ART.	MISURA	PREZZO
QSR08	1/8 - aria	
QSR04	1/4 - aria	
QSR8A	1/8 - acqua	
QSR4A	1/4 - acqua	

tutto in plastica



QZFR **FILTRO RIDUTTORE PRESSIONE -MINI-**

COD. ART.	MISURA	PREZZO
QZFR38R	3/8 radiale	
QZFR38P	3/8 poster.	

A richiesta: rubinetti rapidi di uscita.
Modello standard per compressore



QCL **LUBRIFICATORE SERIE -N-**

COD. ART.	MISURA	PREZZO
QCL08	1/8	
QCL04	1/4	

A richiesta: tazza corta.
Esecuzione: ottone.



QCL **LUBRIFICATORE SERIE -C-**

COD. ART.	MISURA	PREZZO
QCL14	1/4	
QCL38	3/8	
QCL12	1/2	
QCL01	1" - gigante	

Esecuzione: alluminio.



QZFR **FILTRO RIDUTTORE PRESSIONE**

COD. ART.	MISURA	PREZZO
QZFR12R	1/2 radiale	
QZFR12P	1/2 poster.	

A richiesta: rubinetti rapidi di uscita.
Modello standard per compressore



QCFRL **GRUPPO F.R.L. COMPLETO SERIE -N-**

COD. ART.	MISURA	PREZZO
QCFRL08	1/8	
QCFRL04	1/4	

Completo di manometro, nipplo e staffa.
Scarico semi automatico e manuale.
A richiesta: tazza corta.
Esecuzione: ottone.



QCFRL **GRUPPO F.R.L. COMPLETO SERIE -C-**

COD. ART.	MISURA	PREZZO
QCFRL14	1/4	
QCFRL38	3/8	
QCFRL12	1/2	
QCFRL01	1" - gigante	

Completo di manometro e viti fissaggio.
Scarico semi automatico e manuale.
Esecuzione: alluminio.



FLUID **OLIO SPECIALE PER NEBULIZZATORI**

COD. ART.	MISURA	PREZZO
FLUID1	1 lt.	
FLUID5	5 lt.	



MP **MANOMETRO PER RIDUTTORI PRESSIONE**

COD. ART.	MISURA	PREZZO
MP40	1/8	
MP50	1/8-1/4	
MP63	1/4	
MP40E	1/8	
MP50E	1/8	

Esecuzione: ABS.



RICAMBI GRUPPI F.R.L. CAMOZZI

COD. ART.	DESCRIZIONE	MISURA	PREZZO
QCTPF	Tazza plastica filtro	1/8-1/4	
QCTPL	Tazza plastica lubr.	1/8-1/4	
QCTAF	Tazza allum. filtro	3/8-1/2	
QCSSA	Scarico semi autom.	1/4-3/8-1/2	
QCMMN	Membrana rid. -M-N-	1/8-1/4	
QCMRC	Membrana ridutt. -C-	3/8-1/2	
QCCPL	Cupola plastica	1/4-3/8-1/2	

NC **NIPPLLO CONICO -2500-**

COD. ART.	MISURA	PREZZO
NC88	1/8	
NC44	1/4	
NC33	3/8	
NC22	1/2	
NC77	3/4	
NC11	1"	



SRC **SERBATOIO RECUPERO CONDENSA**

COD. ART.	MISURA	PREZZO
SRC07	1" - lt. 7	
SRC15	1 1/2" - lt. 15	
SRC25	2" - lt. 25	

Fornito completo di rubinetto spurgo.
A richiesta: entrata-uscita in linea.
Esecuzione: acciaio con antiruggine.



FCV **FILTRO ARIA A CARBONE VEGETALE**

COD. ART.	MISURA	PREZZO
FCV07	1" - lt. 7	
FCV15	1 1/2" - lt. 15	
FCV01	carica ricambio	
FCV02	carica ricambio	

Fornito completo di rubinetto spurgo.
A richiesta: scaricatore automatico.
Esecuzione: acciaio verniciato.



FCA **FILTRO ARIA A CARBONE ATTIVO**

COD. ART.	MISURA	PREZZO
FCA03	1/2" - lt. 3	
FCA07	1" - lt. 7	
FCA15	1 1/2" - lt. 15	

Fornito completo di rubinetto spurgo.
A richiesta:
tipo con carbone attivo-ceramica porosa,
tipo con cartucce di ceramica porosa.



QJF
QJFD

FILTRO-SEPARATORE CONDENSA

COD. ART.	MISURA	PREZZO
FILTRO SCARICO MANUALE -EAF-		
QJFM5	M5 sr. 1000	
QJF04	1/4 sr. 2000	
QJF14	1/4 sr. 3000	
QJF38	3/8 sr. 3000	
QJF12	1/2 sr. 4000	
QJF34	3/4 sr. 4000	
QJF01	1" sr. 5000	
QJF11	1" sr. 6000	
FILTRO SCARICO AUTOMATICO -EAFD-		
QJF14D	1/4 sr. 3000	
QJF38D	3/8 sr. 3000	
QJF12D	1/2 sr. 4000	
QJF34D	3/4 sr. 4000	
QJF01D	1" sr. 5000	
QJF11D	1" sr. 6000	
QJF06D	1" 1/2 sr. 800	
QJF02D	2" sr. 911	

Cartuccia filtraggio 5 micron standard.

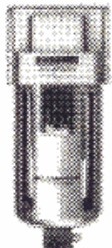

QJFM
QJFMD

MICRO FILTRO SEPARATORE CONDENSA

COD. ART.	MISURA	PREZZO
MICRO FILTRO SCARICO MANUALE -EAFD-		
QJFM04	1/4 sr. 3000	
QJFM38	3/8 sr. 2000	
QJFM12	1/2 sr. 4000	
QJFM34	3/4 sr. 4000	
MICRO FILTRO SCARICO AUTOMATICO -EAFD-		
QJFM38D	3/8 sr. 3000	
QJFM12D	1/2 sr. 4000	
QJFM34D	3/4 sr. 4000	

Cartuccia filtraggio 0,3 micron.

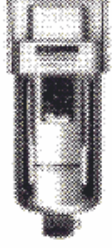

QJFD

SUB MICRO FILTRO -EAFD-

COD. ART.	MISURA	PREZZO
QJFD14	1/4 sr. 3000	
QJFD38	3/8 sr. 3000	
QJFD12	1/2 sr. 4000	
QJFD34	3/4 sr. 4000	

Cartuccia filtraggio 0,01 micron.
Completo di scarico manuale.



QJS

SEPARATORE DI CONDENSA -EAMG-

COD. ART.	MISURA	PREZZO
QJS14	1/4	
QJS38	3/8-750 N.L.	
QJS12	1/2-1500 N.L.	
QJS34	3/4-2200 N.L.	
QJS01	1"-3500 N.L.	
QJBM51	staffa per 1/4	
QJBM52	staffa per 3/8	
QJBM53	staffa per 1/2	
QJBM54	staffa per 3/4	
QJBM55	staffa per 1"	

Completo di scarico automatico.



QJFR
QJFRD

FILTRO RIDUTTORE PRESSIONE -EAW-

COD. ART.	MISURA	PREZZO
CON SCARICO MANUALE		
QJFRM5	M5 sr. 1000	
QJFR04	1/4 sr. 2000	
QJFR14	1/4 sr. 3000	
QJFR38	3/8 sr. 3000	
QJFR12	1/2 sr. 4000	
QJFR34	3/4 sr. 4000	
CON SCARICO AUTOMATICO		
QJFR14D	1/4 sr. 3000	
QJFR38D	3/8 sr. 3000	
QJFR12D	1/2 sr. 4000	
QJFR34D	3/4 sr. 4000	

A richiesta: manometro.

A richiesta: manometro.



QJFRL
QJFRLD

GRUPPO TRATTAMENTO ARIA FR.L.

COD. ART.	MISURA	PREZZO
CON SCARICO MANUALE		
QJFRLM5	M5 sr. 1000	
QJFRL04	1/4 sr. 2000	
QJFRL14	1/4 sr. 3000	
QJFRL38	3/8 sr. 3000	
QJFRL12	1/2 sr. 4000	
QJFRL34	3/4 sr. 4000	
CON SCARICO AUTOMATICO		
QJFRLM5D	M5 sr. 1000	
QJFRL04D	1/4 sr. 2000	
QJFRL14D	1/4 sr. 3000	
QJFRL38D	3/8 sr. 3000	
QJFRL12D	1/2 sr. 4000	
QJFRL34D	3/4 sr. 4000	

Completi con staffa di giunzione e manom.

Completi con staffa di giunzione e manom.



QJR

RIDUTTORE DI PRESSIONE -EAR-

COD. ART.	MISURA	PREZZO
QJRM5	M5 sr. 1000	
QJR04	1/4 sr. 2000	
QJR14	1/4 sr. 3000	
QJR38	3/8 sr. 3000	
QJR12	1/2 sr. 4000	
QJR34	3/4 sr. 4000	
QJR01	1" sr. 5000	
QJR11	1" sr. 6000	

A richiesta: tipi alta pressione.



QJL

LUBRIFICATORE MICRONEBBIA -EAL-

COD. ART.	MISURA	PREZZO
QJLM5	M5 sr. 1000	
QJL04	1/4 sr. 2000	
QJL14	1/4 sr. 3000	
QJL38	3/8 sr. 3000	
QJL12	1/2 sr. 4000	
QJL34	3/4 sr. 4000	
QJL01	1" sr. 5000	

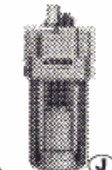

QJRP

RIDUTTORE PRESS. PILOTATO AD ARIA

COD. ART.	MISURA	PREZZO
QJRP12	1/2	
QJRP01	1"	



QJEIR

RIDUTTORE PRESS. DI PRECISIONE

COD. ART.	MISURA	PREZZO
QJEIR200	1/8-0,05-2 bar	
QJEIR201	1/4-0,05-4 bar	
QJEIR202	1/4-0,05-7 bar	



QJAD

SCARICATORE AUT. CONDENSA -EAD-

COD. ART.	MISURA	PREZZO
QJAD38	3/8	
QJAD12	1/2	

A GALLEGGIANTE



RICAMBI

COD. ART.	DESCRIZIONE	SERIE	PREZZO
QJTPF04	Tazza scarico man. filtro	2000	
QJTPF38	Tazza scarico man. filtro	3000	
QJTPF12	Tazza scarico man. filtro	4000	
QJTPF38D	Tazza scarico aut. filtro	3000	
QJTPF12D	Tazza scarico aut. filtro	4000	
QJTPL38	Tazza lubrificatore	3000	
QJTPL12	Tazza lubrificatore	4000	
QJCB04	Cartuccia bronzo 5 micron	2000	
QJCB38	Cartuccia bronzo 5 micron	3000	
QJCB12	Cartuccia bronzo 5 micron	4000	
QJCB01	Cartuccia bronzo 5 micron	5000	
QJFM38R	Cartuccia m.f. disoleatori	3000	
QJFM12R	Cartuccia m.f. disoleatori	4000	
QJMEM04	Membrana gomma	2000	
QJMEM38	Membrana gomma	3000	
QJMEM12	Membrana gomma	4000	
QJCL	Cupola plast.lubrificatore	Tutte	

QJY

GIUNZIONI PER GRUPPI F.R.L.

COD. ART.	MISURA	PREZZO
QJY10T	per sr. 1000	
QJY20T	per sr. 2000	
QJY30T	per sr. 3000	
QJY40T	per sr. 4000	
QJY50T	per sr. 5000	
QJY60T	per sr. 6000	



QJAD

SCARICATORE AUT. CONDENSA -EAD-

COD. ART.	MISURA	PREZZO
QJAD01	1"	

A GALLEGGIANTE CON MANUALE



QJB

SQUADRETTA FISSAGGIO RIDUTTORI

COD. ART.	MISURA	PREZZO
QJB220	per sr. 2000	
QJB320	per sr. 3000	
QJB420	per sr. 4000	

Esecuzione: brunita.



QJADM

SCARICATORE AUT. CONDENSA -EAD-

COD. ART.	MISURA	PREZZO
QJADM	1/2 - 3/8	

ELETTRICO TEMPORIZZATO



MP
QJGD40

MANOMETRI

COD. ART.	MISURA	PREZZO
MP27	1/16 - 27 mm	
MP40	1/8 - 40 mm	
MP50	1/8 - 50 mm	
MP63	1/4 - 63 mm	
QJGD40	1/4 - 62 mm	

Nella foto: manometro differenziale.



QJB

STAFFA FISSAGGIO F.R.L.

COD. ART.	MISURA	PREZZO
QJB240	per sr. 2000	
QJB340	per sr. 3000	
QJB440	per sr. 4000	
QJB540	per sr. 5000	
QJB640	per sr. 6000	



MP

Cassa ABS

COD. ART.	∅	Fil.	PREZZO
MP40	40 - 1/8		
MP50	50 - 1/8		
MP63	63 - 1/4		
VP40	40 - 1/8		
VP50	50 - 1/8		
VP63	63 - 1/4		

MP=manometro • VP=vuotometro

MF

Cassa ABS - flangia acciaio

COD. ART.	∅	Fil.	PREZZO
MF40	40 - 1/8		
MF50	50 - 1/8		
MF63	63 - 1/4		

FLNG* solo flangia
*Solo flangia diametro mm 40-50-63.
Nuova generazione.

MR

Cassa ABS

COD. ART.	∅	Fil.	PREZZO
MR40	40 - 1/8		
MR50	50 - 1/4		
MR63	63 - 1/4		
MR99	100 - 1/2		
VR80	80 - 1/2		
VR99	100 - 1/2		

MR=manometro • VR=vuotometro

MPNG

Cassa ABS

COD. ART.	∅	Fil.	PREZZO
MP40NG	40 - 1/8		
MP50NG	50 - 1/8		
MP63NG	63 - 1/4		

Manometro con bordo in battuta.
Nuova generazione.

MFW - VFV

Cassa ACCIAIO - flangia cromata

COD. ART.	∅	Fil.	PREZZO
MF40W	40 - 1/8		
MF50W	50 - 1/4		
MF63W	63 - 1/4		
VF40W	40 - 1/8		
VF50W	50 - 1/4		
VF63W	63 - 1/4		

MF=manometro • VF=vuotometro

**MRW
VRW**

Cassa ACCIAIO

COD. ART.	∅	Fil.	PREZZO
MR40W	40 - 1/8		
MR50W	50 - 1/4		
MR63W	63 - 1/4		
MR80W	80 - 1/2		
MR99W	100 - 1/2		
MR16W	160 - 1/2		
VR40W	40 - 1/8		
VR50W	50 - 1/4		
VR63W	63 - 1/4		
VR80W	80 - 1/2		
VR99W	100 - 1/2		
VR16W	160 - 1/2		

Cassa acciaio - verniciatura nera.
MR=manometro • VR=vuotometro

MPW - VPW

Cassa ACCIAIO

COD. ART.	∅	Fil.	PREZZO
MP40W	40 - 1/8		
MP50W	50 - 1/4		
MP63W	63 - 1/4		
VP40W	40 - 1/8		
VP50W	50 - 1/4		
VP63W	63 - 1/4		

MP=manometro • VP=vuotometro

MFG - VFG

Cassa INOX - flangia acciaio

COD. ART.	∅	Fil.	PREZZO
MFG63	63 - 1/4		
MFG99	100 - 1/2		
VFG63	63 - 1/4		
VFG99	100 - 1/2		

MFG=manometro • VFG=vuotometro

MRG - VRG

Cassa INOX - racc. ottone

COD. ART.	∅	Fil.	PREZZO
MRG50	50 - 1/4		
MRG63	63 - 1/4		
MRG99	100 - 1/2		
VRG63	63 - 1/4		
VRG99	100 - 1/2		

MR=manometro • VR=vuotometro

MPG - VPG

Cassa INOX - racc. ottone

COD. ART.	∅	Fil.	PREZZO
MPG50	50 - 1/4		
MPG63	63 - 1/4		
MPG99	100 - 1/2		
VPG63	63 - 1/4		
VPG99	100 - 1/2		

MP=manometro • VP=vuotometro

MSG - VSG

Cassa INOX - staffa acciaio

COD. ART.	∅	Fil.	PREZZO
MSG50	50 - 1/4		
MSG63	63 - 1/4		
MSG99	100 - 1/2		
VSG50	50 - 1/4		
VSG63	63 - 1/4		
VSG99	100 - 1/2		

MS=manometro • VS=vuotometro

MRX - MRGX

Tutto INOX

COD. ART.	∅	Fil.	PREZZO
MR63X	63 - 1/4		
MR99X	100 - 1/2		
MRG63X	63 - 1/4		
MRG99X	100 - 1/2		
MRG16X	160 - 1/2		

MR=man. a secco • MRG=man. glicerina
A richiesta: Vuotometri.

MPX - MPGX

Tutto INOX

COD. ART.	∅	Fil.	PREZZO
MP63X	63 - 1/4		
MP99X	100 - 1/2		
MPG63X	63 - 1/4		
MPG99X	100 - 1/2		

MP=man. a secco • MPG=man. glicerina
A richiesta: Vuotometri.

MS

Cassa ABS - staffa acciaio

COD. ART.	∅	Fil.	PREZZO
MS40	40 - 1/8		
MS50	50 - 1/8		
MS63	63 - 1/4		

STNG* solo staffa
*Solo staffa diametro mm 40-50-63.
Nuova generazione.

RFT

RACCORDO GIREVOLE RFT

COD. ART.	∅	Fil.	PREZZO
RFT44G	1/4 - 1/4		
RFT24G	1/2 - 1/4		
RFT22G	1/2 - 1/2		

MSW - VSW

Cassa ACCIAIO - staffa acciaio

COD. ART.	∅	Fil.	PREZZO
MS40W	40 - 1/8		
MS50W	50 - 1/4		
MS63W	63 - 1/4		
VS40W	40 - 1/8		
VS50W	50 - 1/4		
VS63W	63 - 1/4		

MS=manometro • VS=vuotometro

MVAP

Cassa ACCIAIO VAPORE

COD. ART.	∅	Fil.	PREZZO
MVAP63	63 - 1/4		
MVAP80	80 - 3/8		
MVAP99	100 - 1/2		
MVAP16	160 - 1/2		

Dal diametro 80 con lancetta rossa.
Costruito con pressione max 40 bar.
Schermo in cristallo • Vapore 200°

RFT

RUBINETTO ESCLUSORE

COD. ART.	∅	Fil.	PREZZO
RFT291	1/4M - 1/4F		

Alta pressione - Raccordo orientabile

SCALE STANDARD DISPONIBILI

PRESSIONE in bar			PRESS. in mbar		VIUOTO
0-0,6	0-12	0-250	0-25	0-600	-1-0 bar
0-1	0-16	0-315	0-40		-1-76 Cm HG
0-1,6	0-25	0-400	0-60		400-0 mbar
0-2,5	0-40	0-600	0-100		250-0 mbar
0-4	0-60	0-1000	0-160		160-0 mbar
0-6	0-100		0-250		100-0 mbar
0-10	0-160		0-400		40-0 mbar

MGAS

Cassa ACCIAIO GAS METANO

COD. ART.	∅	Fil.	PREZZO
MGAS63	63 - 1/4		
MGAS99	100 - 1/2		
MGAS16	160 - 1/2		

A richiesta: attacco post. • vuotometro • protezione 10 volte la scala.
Completo di vite regolazione lancetta.

RFT

RUBINETTO ESCLUSORE

COD. ART.	∅	Fil.	PREZZO
RFT290	1/4M - 1/4F		

Alta pressione - Raccordo orientabile

MC

MANOMETRO A CAMPIONE

COD. ART.	∅	Fil.	PREZZO
MC160*	160 - 1/2		

*Suddivisione 0,2
A richiesta: classe 0,25 suddivisione 0,1
Riempimento liquido • Attacco posteriore • Fissaggio a flangia • Certificato di fabbrica • Indice di trascinamento • Valigetta • Acciaio INOX • Vuotometro

MRCE

Cassa ACCIAIO

COD. ART.	∅	Fil.	PREZZO
MRCE99	100 - 1/2		
MRCE16	160 - 1/2		

A richiesta: 1 contatto o 3 contatti.
Nella foto, manometro a 2 contatti.

VALVOLE A SFERA PER ACQUA-ARIA-GAS-OLIO-VAPORE

9-97

RUSB VALVOLA -2 VIE- MINIBALL -1502-

COD. ART.	filetto	Ø	PR. MAX	confez.	PREZZO
RUSB8M	1/8	5,5	10	24	
RUSB4M	1/4	5,5	10	24	
RUSB3M	3/8	8	10	24	
RUSB2M	1/2	10	10	24	

Esecuzione: nichelata brillante.
Disponibile anche con raccordo a resca e per tubi rame.

RUSB VALVOLA -2 VIE- MINIBALL -1501-

COD. ART.	filetto	Ø	PR. MAX	confez.	PREZZO
RUSB8F	1/8	5,5	10	24	
RUSB4F	1/4	5,5	10	24	
RUSB3F	3/8	8	10	24	
RUSB2F	1/2	10	10	24	

Esecuzione: nichelata brillante.
Disponibile anche con raccordo a resca e per tubi rame.

RUSV VALVOLA -2 VIE- MINI SFER -3931-

COD. ART.	filetto	Ø	PR. MAX	confez.	PREZZO
RUSV4M	1/4	8	10		
RUSV3M	3/8	8	10		
RUSV2M	1/2	10	10		

Esecuzione: cromata.

RUSV VALVOLA -2 VIE- MINI SFER -3930-

COD. ART.	filetto	Ø	PR. MAX	confez.	PREZZO
RUSV4F	1/4	8	10		
RUSV3F	3/8	8	10		
RUSV2F	1/2	10	10		

Esecuzione: cromata.

RUST VALVOLA -2 VIE- MERCURY -0422-

COD. ART.	filetto	Ø	PR. MAX	confez.	PREZZO
RUST4M	1/4	8	50	25	
RUST3M	3/8	10	50	25	
RUST2M	1/2	15	40	20	

La pressione max si intende per temperature da 0-20°

RUST VALVOLA -2 VIE- MERCURY -0421-

COD. ART.	filetto	Ø	PR. MAX	confez.	PREZZO
RUST4F	1/4	10	50	25	
RUST3F	3/8	10	50	25	
RUST2F	1/2	15	40	20	

La pressione max si intende per temperature da 0-20°

RUSL VALVOLA -2 VIE- MERCURY -0402-

COD. ART.	filetto	Ø	PR. MAX	confez.	PREZZO
RUSL4M	1/4	8	50	16	
RUSL3M	3/8	10	50	16	
RUSL2M	1/2	15	40	16	
RUSL7M	3/4	20	40	12	
RUSL1M	1"	25	32	8	
RUSL5M	1" 1/4	32	25	6	
RUSL6M	1" 1/2	32	25	4	
RUSL9M	2"	40	20	4	

La press. max si intende a 0-20° - Disponibile fino a 2" 1/2

RUSL VALVOLA -2 VIE- MERCURY -0401-

COD. ART.	filetto	Ø	PR. MAX	confez.	PREZZO
RUSL4F	1/4	10	50	16	
RUSL3F	3/8	10	50	16	
RUSL2F	1/2	15	40	16	
RUSL7F	3/4	20	40	12	
RUSL1F	1"	25	32	8	
RUSL5F	1" 1/4	32	25	6	
RUSL6F	1" 1/2	32	25	6	
RUSL9F	2"	40	20	4	

La press. max si intende a 0-20° - Disponibile fino a 4'

RUSQ VALVOLA -2 VIE- FIDO SFER -9068-

COD. ART.	filetto	Ø	PR. MAX	confez.	PREZZO
RUSQ2F	1/2	15	16		
RUSQ7F	3/4	20	16		
RUSQ1F	1"	25	16		

A richiesta filetto maschio/femmina e con portagomma.

RUSZ VALVOLA -2VIE- HIPRESS -2321-

COD. ART.	filetto	Ø	PR. MAX	confez.	PREZZO
RUSZ3F	3/8	8	210	12	
RUSZ2F	1/2	12	210	8	
RUSZ7F	3/4				

RUSY VALVOLA -3 VIE- -L- DELTA -1150-

COD. ART.	filetto	Ø	PR. MAX	confez.	PREZZO
RUSY4F	1/4	8	10	6	
RUSY3F	3/8	10	10	6	
RUSY2F	1/2	15	10	5	
RUSY7F	3/4	20	10	4	
RUSY1F	1"	25	10	5	

A richiesta con sfera forata a "T".

RUSS VALVOLA -2 VIE- ALTA PRESS. ACCIAIO FT221/1

COD. ART.	filetto	Ø	PR. MAX	confez.	PREZZO
RUSS4F	1/4	6	400	1	
RUSS3F	3/8	10	400	1	
RUSS2F	1/2	15	400	1	

A richiesta fino a 3" - Disponibile anche a 3 VIE.

RUSJ VALVOLA -3 VIE- -L- DEVIA SFER -3210-

COD. ART.	filetto	Ø	PR. MAX	confez.	PREZZO
RUSJ4F	1/4	10	25	15	
RUSJ3F	3/8	10	25	15	
RUSJ2F	1/2	15	25		
RUSJ7F	3/4	20	16		
RUSJ1F	1"	25	16		

A richiesta con sfera forata a "T".

RUSX VALVOLA -2 VIE- INOX 316 SUN -2501-

COD. ART.	filetto	Ø	PR. MAX	confez.	PREZZO
RUSX4F	1/4	10	160		
RUSX3F	3/8	10	160		
RUSX2F	1/2	15	160		
RUSX7F	3/4	20			
RUSX1F	1"	25			

A richiesta lucidate - Disponibile anche a 3 VIE.

RUSP VALVOLA -3 VIE- DEVIA SFER -5710-

COD. ART.	filetto	Ø	PR. MAX	confez.	PREZZO
RUSP4F	1/4	8	10		

Adatta per fissaggio a pannello.
E' possibile anche la chiusura simultanea delle 2 vie di uscita.

RUSA VALVOLA -2VIE- EURO SFER -4924-

COD. ART.	filetto	Ø	PR. MAX	confez.	PREZZO
RUSA3M	3/8	10	30		
RUSA2M	1/2	10	30		
RUSA7M	3/4	12	30		
RUSA1M	1"	15	30		

A richiesta leva lunga.

VDA VNC

VALVOLA DI INTERCETTAZ. -VIP-

COD. ART.	MISURA	PREZZO
VALVOLA A DOPPIO EFFETTO		
VDA038	3/8	
VDA012	1/2	
VDA034	3/4	
VDA001	1"	
VDA114	1" - 1/4	
VDA112	1" - 1/2	
VDA002	2"	
VALVOLA A SEMPLICE EFFETTO		
VNC038	3/8	
VNC012	1/2	
VNC034	3/4	
VNC001	1"	
VNC114	1" - 1/4	
VNC112	1" - 1/2	
VNC002	2"	

OTTONE

A richiesta: con F.C. magnetici e con guarnizioni Viton per alta temp.

VSD

VALVOLA A SFERA -OMAL-

COD. ART.	MISURA	PREZZO
VALVOLA A DOPPIO EFFETTO		
VSD038	3/8	
VSD012	1/2	
VSD034	3/4	
VSD001	1"	
VSD114	1" - 1/4	
VSD112	1" - 1/2	
VSD002	2"	

OTTONE

VSX

VALVOLA A SFERA -OMAL-

COD. ART.	MISURA	PREZZO
VALVOLA A DOPPIO EFFETTO		
VSX038	3/8	
VSX012	1/2	
VSX034	3/4	
VSX001	1"	
VSX112	1" - 1/2	
VSX002	2"	

INOX

A richiesta: S.E. - lucidatura valvola.

VAP

VALVOLA A SFERA -OMAL-

COD. ART.	MISURA	PREZZO
VALVOLA A DOPPIO EFFETTO		
VAP038	3/8	
VAP012	1/2	
VAP034	3/4	
VAP001	1"	
VAP112	1" - 1/2	
VAP002	2"	

ACCIAIO Alta Pressione

A richiesta: semplice effetto e 3 vie.

V3L

VALVOLA A SFERA -OMAL-

COD. ART.	MISURA	PREZZO
VALVOLA A DOPPIO EFFETTO		
V3L038	3/8	
V3L012	1/2	
V3L034	3/4	
V3L001	1"	
V3L112	1" - 1/2	
V3L002	2"	

OTTONE

A richiesta: semplice effetto.

VSP

VALVOLA A SFERA -OMAL-

COD. ART.	MISURA	PREZZO
VALVOLA A DOPPIO EFFETTO		
VSP038	3/8	
VSP012	1/2	
VSP034	3/4	
VSP001	1"	
VSP112	1" - 1/2	
VSP002	2"	

P.V.C.

A richiesta: semplice effetto e 3 vie.

VSF

VALVOLA A SFERA -OMAL-

COD. ART.	MISURA	PREZZO
VALVOLA A DOPPIO EFFETTO		
VSF010	DN 10	
VSF015	DN 15	
VSF020	DN 20	
VSF025	DN 25	

A richiesta: S.E. - 3 vie - acciaio inox.

VDF

VALVOLA A FARFALLA -OMAL-

COD. ART.	MISURA	PREZZO
VALVOLA A DOPPIO EFFETTO		
VDF040	DN 40	
VDF050	DN 50	
VDF065	DN 65	
VDF080	DN 80	

A richiesta: S.E. - DN 400 max.

A331

ELETTROVALVOLA S.E. - 3 VIE - N.C.

COD. ART.	DIMENS.	PREZZO
A3313C2		

BOBINA*

*Richiedere voltaggio. Il prezzo è per corrente alternata. Da applicare su tutte le valvole S.E.

VSR

VALVOLA RICAMBIO -VSD-VSS-

COD. ART.	MISURA	PREZZO
VSR038	3/8	
VSR012	1/2	
VSR034	3/4	
VSR001	1"	
VSR112	1" - 1/2	
VSR002	2"	

ADA

ATTUATORE PNEUMATICO 90° D.E.

COD. ART.	DIMENS.	PREZZO
ADA015	L 114-H 73	
ADA030	L 140-H 84	
ADA060	L 162-H 98	
ADA120	L 192-H115	
ADA240	L 255-H142	

ALLUMINIO

A richiesta: F.C. magnetici.

IDA

ATTUATORE PNEUM. ISO-DIN 90° D.E.

COD. ART.	DIMENS.	PREZZO
IDA008	L 70-H 60	
IDA015	L 114-H 75	
IDA030	L 140-H 82	
IDA060	L 162-H 102	
IDA120	L 192-H 119	

ALLUMINIO

A richiesta: F.C. magnetici e acciaio

V3R

VALVOLA RICAMBIO -V3L-

COD. ART.	MISURA	PREZZO
V3R038	3/8	
V3R012	1/2	
V3R034	3/4	
V3R001	1"	
V3R112	1" - 1/2	
V3R002	2"	

ASR

ATTUATORE PNEUMATICO 90° S.E.

COD. ART.	DIMENS.	PREZZO
ASR015	L 114-H 73	
ASR030	L 140-H 84	
ASR060	L 162-H 98	
ASR120	L 192-H115	
ASR240	L 255-H142	

ALLUMINIO

A richiesta: F.C. magnetici.

ISR

ATTUATORE PNEUM. ISO-DIN 90° S.E.

COD. ART.	DIMENS.	PREZZO
ISR015	L 244-H 82	
ISR030	L 269-H 102	
ISR060	L 334-H 119	
ISR120	L 395-H 139	
ISR240	L 487-H 163	

ALLUMINIO

A richiesta: F.C. magnetici e acciaio

F

VALVOLA A SFERA -VALVAUT-

COD. ART.	MISURA	PREZZO
VALVOLA A DOPPIO EFFETTO		
F012DE	1/2	
F034DE	3/4	
F001DE	1"	
F114DE	1" - 1/4	
F112DE	1" - 1/2	
F002DE	2"	
VALVOLA A SEMPLICE EFFETTO		
F012SE	1/2	
F034SE	3/4	
F001SE	1"	
F114SE	1" - 1/4	
F112SE	1" - 1/2	
F002SE	2"	

OTTONE

A richiesta: F.C. magnetici e acciaio

B

VALVOLA A TAMPONE -VALVAUT-

COD. ART.	MISURA	PREZZO
VALVOLA A DOPPIO EFFETTO		
B012DE	1/2	
B034DE	3/4	
B001DE	1"	
B114DE	1" - 1/4	
B112DE	1" - 1/2	
B002DE	2"	
VALVOLA A SEMPLICE EFFETTO		
B012SE	1/2	
B034SE	3/4	
B001SE	1"	
B114SE	1" - 1/4	
B112SE	1" - 1/2	
B002SE	2"	

OTTONE

A richiesta: con passaggio a squadra.

A

VALVOLA A SARACINESCA -VALVAUT-

COD. ART.	MISURA	PREZZO
VALVOLA A DOPPIO EFFETTO		
A034DE	3/4	
A001DE	1"	
A112DE	1" - 1/2	
A002DE	2"	
A003DE	3"	

A richiesta: semplice effetto.

FSV

VALVOLA PER VAPORE -VALVAUT-

COD. ART.	MISURA	PREZZO
VALVOLA A SEMPLICE EFFETTO		
FSV012SE	1/2	
FSV034SE	3/4	
FSV001SE	1"	

VAPORE

A richiesta: acciaio inox.

133

ELETTROVALVOLA ACQUA - ARIA - 2 VIE - N.C.

COD. ART.	FILETTO passo gas	Ø DN	MIN. bar	PR. c.a.	MAX. c.c.	TEMPERAT. FLUIDO	PREZZO
133INZ*	3/8	13	0,1	20	20	-10 +90	
133ANZ*	1/2	13	0,1	20	20	-10 +90	
133CNZ*	3/4	20	0,1	20	20	-10 +90	
133DNZ*	1"	25	0,1	20	20	-10 +90	
133ENZ*	1" 1/4	35	0,1	10	10	-10 +90	
133FNZ*	1" 1/2	40	0,1	10	10	-10 +90	
133GNZ*	2"	50	0,1	10	10	-10 +90	

MODELLO STANDARD

usare bobina ZB09-C.A.
usare bobina ZB12-C.C.

ELETTROVALVOLA ACQUA - VAPORE - 2 VIE - N.C.

COD. ART.	FILETTO passo gas	Ø DN	MIN. bar	PR. c.a.	MAX. c.c.	TEMPERAT. FLUIDO	PREZZO
133IHZ	3/8	13	0,1	4	4	-10 +140	
133AHZ	1/2	13	0,1	4	4	-10 +140	
133CHZ	3/4	20	0,1	4	4	-10 +140	
133DHZ	1"	25	0,1	4	4	-10 +140	

140° 140°

143

ELETTROVALVOLA ACQUA - ARIA - OLIO - 2 VIE - N.A.

COD. ART.	FILETTO passo gas	Ø DN	MIN. bar	PR. c.a.	MAX. c.c.	TEMPERAT. FLUIDO	PREZZO
143INZ	3/8	13	0,1	20	20	-10 +90	
143ANZ*	1/2	13	0,1	20	20	-10 +90	
143CNZ*	3/4	20	0,1	20	20	-10 +90	
143DNZ*	1"	25	0,1	20	20	-10 +90	

(NORM. APERTA)

usare bobina ZB14-C.A. - usare bobina ZB16-C.C.

168

ELETTROVALVOLA ARIA - 2 VIE - N.C.

COD. ART.	FILETTO passo gas	Ø DN	MIN. bar	PR. c.a.	MAX. c.c.	TEMPERAT. FLUIDO	PREZZO
168INZ	3/8	13	0,1	20	20	-10 +90	
168ANZ*	1/2	13	0,1	20	20	-10 +90	
168CNZ	3/4	20	0,1	20	20	-10 +90	
168DNZ	12	25	0,1	20	20	-10 +90	

PER ARIA

usare bobina ZB09-C.A. - usare bobina ZB12-C.C.

174

ELETTROVALVOLA ACQUA - ARIA - GAS - OLIO

COD. ART.	FILETTO passo gas	Ø DN	MIN. bar	PR. c.a.	MAX. c.c.	TEMPERAT. FLUIDO	PREZZO
174AVZ*	1/8	1,5	0	20	15	-10 +140	
174VWZ*	1/4	2,5	0	10	6	-10 +140	

usare bobina WB45-C.A. - usare bobina WB05-C.C.

123

ELETTROVALVOLA ACQUA - ARIA - OLIO - 2 VIE - N.C.

COD. ART.	FILETTO passo gas	Ø DN	MIN. bar	PR. c.a.	MAX. c.c.	TEMPERAT. FLUIDO	PREZZO
123AVZ	1/2	13	0	5	1	-10 +140	

usare bobina ZB09-C.A. - usare bobina ZB12-C.C.

161

ELETTROVALVOLA ACQUA - VAPORE - 2 VIE - N.C.

COD. ART.	FILETTO passo sept.	Ø DN	MIN. bar	PR. c.a.	MAX. c.c.	TEMPERAT. FLUIDO	PREZZO
161AVZ*	1/4	2,2	0	10	10	-10 +140	
161EVZ	1/4	2,2	0	10	10	-10 +140	

usare bobina KT09-C.A. - usare bobina KF10-C.C.

139

ELETTROVALVOLA ACQUA - ARIA - GAS - OLIO - 3 VIE - N.C.-N.A.

COD. ART.	FILETTO passo gas	Ø DN	MIN. bar	PR. c.a.	MAX. c.c.	TEMPERAT. FLUIDO	PREZZO
139FVZ	1/4	2	0	7	7	-10 +140	

usare bobina ZB09-C.A. - usare bobina ZB12-C.C.

146

ELETTROVALVOLA ACQUA - ARIA - GAS - OLIO - 2 VIE - N.C.

COD. ART.	FILETTO passo gas	Ø DN	MIN. bar	PR. c.a.	MAX. c.c.	TEMPERAT. FLUIDO	PREZZO
146YVZ*	1/4	3	0	10	8	-10 +140	
146ABZ*	1/4	6	0	8	1	-10 +140	

146YVZ = usare bobina ZB09-C.A. - usare bobina ZB12-C.C.
146ABZ = usare bobina ZB14-C.A. - usare bobina ZB16-C.C.

141

ELETTROVALVOLA ACQUA - ARIA - GAS - OLIO - 3 VIE - N.C.

COD. ART.	FILETTO passo gas	Ø DN	MIN. bar	PR. c.a.	MAX. c.c.	TEMPERAT. FLUIDO	PREZZO
141FVZ	1/4	2	0	10	10	-10 +140	
141GVZ*	1/4	2,5	0	7	7	-10 +140	

3 VIE N.C.

usare bobina ZB09-C.A. - usare bobina ZB12-C.C.

135

ELETTROVALVOLA VAPORE - 2 VIE - N.C.

COD. ART.	FILETTO passo gas	Ø DN	MIN. bar	PR. c.a.	MAX. c.c.	TEMPERAT. FLUIDO	PREZZO
156IRZ	3/8	10	0,5	6,5	-	-30 +160	
156ARZ*	1/2	10	0,5	6,5	-	-30 +160	
156CRZ	3/4	18	0,5	6,5	-	-30 +160	
GOLD34	3/4	19,1		19,1		+178	

N.B.: la figura non corrisponde ai dati indicati - usare bobina ZB09-C.A.

158

ELETTROVALVOLA ACQUA - VAPORE - 2 VIE - N.C.

COD. ART.	FILETTO passo gas	Ø DN	MIN. bar	PR. c.a.	MAX. c.c.	TEMPERAT. FLUIDO	PREZZO
158IHZ*	1/4	3	0	10	4	-10 +140	
158ITZ	1/4	3	0	10	10	-30 +180	

158IHZ = usare bobina ZB09-C.A. - usare bobina ZB12-C.C.
158ITZ = usare bobina ZH14-C.A. - usare bobina ZH16-C.C.

BOBINE

COD. ART.	PREZZO
VB45*	C.A.
VB05*	C.C.

usare connettore ULR2 (PG9)

KF09*	C.A.
KF10	C.C.
KT09*	C.A.
ZB09*	C.A.
ZB12*	C.C.
ZB14*	C.A.
ZH14*	C.A.
JB14*	C.A.
JB16	C.C.
DHPH*	C.A.

Usare connettore ULR1 (PG11)
Voltaggi: 12,00 - 24,00 - 24,50 - 110,50 - 220,50

133S

STAFFETTA FISSAGGIO

COD. ART.	cod.PARKER	PREZZO
133S	1700026P	

non idonea per articoli 174

133

MEMBRANE RICAMBIO

COD. ART.	MISURA	PREZZO
133A 306100	3/8 1/2	
133B 306120	3/4 1"	
133C 306133	1" 1/4 1" 1/2	
133D 306140	2"	
133H 306110	3/8 1/2	
133I 306130	3/4 1"	

ULR

CONNETTORE ELETTRICO

COD. ART.	TIPO	PREZZO
ULR1	quadro	
ULR2	rettang.	
ULR1 led	quadro	
ULR2 led	rettang.	

NOTE:

* Disponibile in magazzino.

Tutti i prezzi delle elettrovalvole sono comprensivi di bobina a corrente alternata e connettore.

Per elettrovalvole a corrente continua, vedere differenza prezzo bobina.

Molti modelli sono adatti per "vuoto", per liquidi e fluidi diversi da quelli indicati, specialmente i tipi con tenuta VITON.

VALVOLE PNEUMATICHE

7-97

234-235 VALVOLA A TASTO -3VIE-
 COD. ART. Filett. Posiz. PREZZO

234945	tubo 4	N.C.	
235945	M5	N.C.	



Mini-valvola

234-235 VALVOLA A TASTO -3VIE-
 COD. ART. Filett. Posiz. PREZZO

234985	tubo 4	N.C.	
235985	M5	N.C.	



Mini-valvola

935-936 VALVOLA A TASTO -3VIE-
 COD. ART. Racc. Posiz. PREZZO

935	tubo 4	N.C.	
936	tubo 4	N.A.	

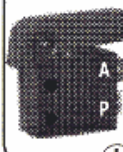

Mini-valvola

234-235 VALVOLA A RULLO -3VIE-
 COD. ART. Filett. Posiz. PREZZO

234955	tubo 4	N.C.	
235955	M5	N.C.	

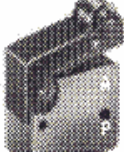

Mini-valvola

234-235 VALVOLA UNIDIREZ. -3VIE-
 COD. ART. Filett. Posiz. PREZZO

234965	tubo 4	N.C.	
235965	M5	N.C.	



Mini-valvola

234 - 235 VALVOLA A TASTO -3VIE-
 COD. ART. Racc. Posiz. PREZZO

234000	tubo 4	N.C.	
235000	tubo 4	N.A.	

Predisposta per pulsantiera Breter



Mini-valvola

PXB VALVOLA A TASTO -3VIE-
 COD. ART. Racc. Posiz. PREZZO

PXBNCT	4 mm	N.C.	
PXBNAT	4 mm	N.A.	

ZB2BA2 solo tasto
 ZB2BG2 tasto+chiave



DN 1,5 - Colore: nero, rosso, verde.

PXB VALVOLA A FUNGO -3VIE-
 COD. ART. Racc. Posiz. PREZZO

PXBNCF	4 mm	N.C.	
PXBNAF	4 mm	N.A.	

ZB2BC4 solo tasto
 ZB2BT4 tasto+blocco
 ZB2BS54 tasto+chiave



DN 1,5 - Colore: rosso.

PXB VALVOLA A SELETTORE -3VIE-
 COD. ART. Racc. Posiz. PREZZO

PXBNCS	4 mm	N.C.	
PXBNAS	4 mm	N.A.	

ZB2BD2 selett. 2 pos.
 ZB2BD3 selett. 3 pos.



DN 1,5 - Colore: nero.

ZB2 MICRO INTERRUPTORE ELETTRICO
 COD. ART. Posiz. PREZZO

ZB2BE101	in chius.	N.A.	
ZB2BE102	in apert.	N.C.	



PXB VALVOLA CON SUPP. -3VIE-
 COD. ART. Racc. Posiz. PREZZO

PXBB1011	4 mm	N.C.	
PXBB1021	4 mm	N.A.	

BZ009 solo supporto
 PXBB1911 solo valv. N.C.
 PXBB1921 solo valv. N.A.



DN 1,5 - Da utilizzare con teste ZB2.

PRT TEMPORIZZATORE PNEUMATICO
 COD. ART. Tempi - Pos. PREZZO

PRTA10	0,1-30 sec.	N.C.	
PRTB10	10-180 sec.	N.C.	
PRTC10	0,1-30 sec.	N.A.	
PRTD10	10-180 sec.	N.A.	

BAMAX base filett. 1/8

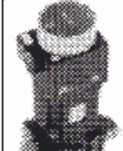

PWS SUPPORTO PORTA "NOT"
 COD. ART. Filettatura PREZZO

PWSB188	1/8	
PWSB199	1/4	



Da utilizzarsi con valvola "NOT".

PWS VALVOLA LOGICA "NOT"
 COD. ART. Racc. Posiz. PREZZO

PWSP111	4 mm	N.A.	
---------	------	------	--



Da utilizzarsi con supporto porta "NOT".

RUC VALVOLA A CORSOIO -3VIE-
 COD. ART. Filett. Posiz. PREZZO

RUC8F	1/8	N.C.	
RUC4F	1/4	N.C.	
RUC3F	3/8	N.C.	
RUC2F	1/2	N.C.	



DS VALVOLA SELETRICE CIRCUITO
 COD. ART. Filett. Posiz. PREZZO

DS8	1/8	
DS4	1/4	
DS2	1/2	



EVM VALVOLA A RULLO -3VIE-
 COD. ART. Filett. Posiz. PREZZO

EVM13R	1/8	N.C.	
EVM10R*	resca 2 mm		



* Valvola miniaturizzata.

MIVL MINI VALVOLA A LEVA -3VIE-
 COD. ART. Filett. Posiz. PREZZO

MIVL	M5	N.C.	
------	----	------	--



Mini-valvola

VDB VALVOLA DI BLOCCO
 COD. ART. Filett. Posiz. PREZZO

VDB8	1/8	N.C.	
VDB4	1/4	N.C.	

Valvola di sicurezza per cilindri pneumatici.
 A richiesta: tipo unidirezionale.

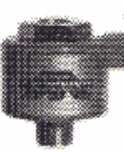

EVM VALVOLA SELETRICE -3VIE-
 COD. ART. Filett. Posiz. PREZZO

EVM13S	1/8	N.C.	
--------	-----	------	--

EVM130 solo valvola
 EVM34A solo attuatore

Selettore 2 posizioni stabili.
 Colori: rosso, verde.



EVM VALVOLA A LEVA -3VIE-
 COD. ART. Filett. Posiz. PREZZO

EVM13L	1/8	N.C.	
--------	-----	------	--

Leva a 2 posizioni stabili.



338 VALVOLA A LEVETTA -3VIE-
 COD. ART. Filett. Posiz. PREZZO

338990	1/8	N.C.	
--------	-----	------	--

Levetta a 2 posizioni stabili.



358 VALVOLA A LEVETTA -5VIE-
 COD. ART. Filett. Posiz. PREZZO

358990	1/8	C.A.	
--------	-----	------	--

Levetta a 2 posizioni stabili.
 C.A. = chiusa aperta.



EVH VALVOLA ROTANTE -4VIE-
 COD. ART. Filett. Posiz. PREZZO

EVH212	1/4	C.A.	
EVH211	1/4	C.AP.	
EVH210	1/4	C.CH.	

Valvole rotanti con leva a 3 posizioni.
 C.A. = chiusa aperta.
 C.AP. = centri aperti- C.CH. = centri chiusi



CS AS VALVOLA A SFERA -3 VIE-

COD. ART.	Filett.	Posiz.	PREZZO
CS8	1/8	N.C.	
CS4	1/4	N.C.	
CS2	1/2	N.C.	
FCR8 spec.	1/8	N.C.	
AS8	1/8	N.A.	
AS4	1/4	N.A.	
AS2	1/2	N.A.	



CLR ALR VALVOLA A RULLO BIDIREZ.-3 VIE-

COD. ART.	Filett.	Posiz.	PREZZO
CLR8	1/8	N.C.	
CLR4	1/4	N.C.	
CLR2	1/2	N.C.	
FCLR8 spec.	1/8	N.C.	
ALR8	1/8	N.A.	
ALR4	1/4	N.A.	
ALR2	1/2	N.A.	



CLRU ALRU VALVOLA A RULLO UNIDIR. -3 VIE-

COD. ART.	Filett.	Posiz.	PREZZO
CLRU8	1/8	N.C.	
CLRU4	1/4	N.C.	
CLRU2	1/2	N.C.	
FCLRU8 spec.	1/8	N.C.	
ALRU8	1/8	N.A.	
ALRU4	1/4	N.A.	
ALRU2	1/2	N.A.	



CASS VALVOLA A SFERA -5 VIE-

COD. ART.	Filett.	Posiz.	PREZZO
CASS8	1/8	C.A.	
CASS4	1/4	C.A.	
CASS2	1/2	C.A.	



C.A.= chiusa aperta.

CALR VALVOLA A RULLO BIDIREZ.-5 VIE-

COD. ART.	Filett.	Posiz.	PREZZO
CALR8	1/8	C.A.	
CALR4	1/4	C.A.	
CALR2	1/2	C.A.	



C.A.= chiusa aperta.

CALRU VALVOLA A RULLO UNIDIR. -5 VIE-

COD. ART.	Filett.	Posiz.	PREZZO
CALRU8	1/8	C.A.	
CALRU4	1/4	C.A.	
CALRU2	1/2	C.A.	



C.A.= chiusa aperta.

CA AR VALVOLA A RULLO UNIDIR. -3 VIE-

COD. ART.	Filett.	Posiz.	PREZZO
CR8	1/8	N.C.	
FCR8 spec.	1/8	N.C.	
AR8	1/8	N.A.	



CT AT VALVOLA A TASTO -3 VIE-

COD. ART.	Filett.	Posiz.	PREZZO
CT8	1/8	N.C.	
CT4	1/4	N.C.	
CT2	1/2	N.C.	
FACT8 spec.	1/8	N.C.	
AT8	1/8	N.A.	
AT4	1/4	N.A.	
AT2	1/2	N.A.	



CAT VALVOLA A TASTO -5 VIE-

COD. ART.	Filett.	Posiz.	PREZZO
CAT8	1/8	C.A.	
CAT4	1/4	C.A.	
CAT2	1/2	C.A.	



C.A.= chiusa aperta.

338 348 VALVOLA A TASTO -3 VIE-

COD. ART.	Filett.	Posiz.	PREZZO
338D15	1/8	N.C.	
348D15	1/8	N.A.	

CAMOZZI

SENSIBILE



N.C.= norm. chiusa • N.A.= norm. aperta

CML AML VALVOLA A LEVA LATERALE -3 VIE-

COD. ART.	Filett.	Posiz.	PREZZO
CML8F	1/8	N.C.	
CML4F	1/4	N.C.	
AML8F	1/8	N.A.	
AML4F	1/4	N.A.	



Tipo a 2 posizioni stabili.
Disponibili anche instabili (senza F finale).

CM AM VALVOLA A LEVA -3 VIE-

COD. ART.	Filett.	Posiz.	PREZZO
CM8F	1/8	N.C.	
CM4F	1/4	N.C.	
AM8F	1/8	N.A.	
AM4F	1/4	N.A.	



Tipo a 2 posizioni stabili.
Disponibili anche instabili (senza F finale).

358 VALVOLA A TASTO -5 VIE-

COD. ART.	Filett.	Posiz.	PREZZO
358D15	1/8	C.A.	

CAMOZZI

SENSIBILE



C.A.= chiusa aperta.

CAML VALVOLA A LEVA LATERALE -5 VIE-

COD. ART.	Filett.	Posiz.	PREZZO
CAML8F	1/8	C.A.	
CAML4F	1/4	C.A.	



Tipo a 2 posizioni stabili.
Disponibili anche instabili (senza F finale).
C.A.= chiusa aperta.

CAM VALVOLA A LEVA -5 VIE-

COD. ART.	Filett.	Posiz.	PREZZO
CAM8F	1/8	C.A.	
CAM4F	1/4	C.A.	
CAM2F	1/2	C.A.	



Tipo a 2 posizioni stabili.
Disponibili anche instabili (senza F finale).
C.A.= chiusa aperta.

CQB AQB VALVOLA A PULSANTE -3 VIE-

COD. ART.	Filett.	Posiz.	PREZZO
CQB8	1/8	N.C.	
AQB8	1/8	N.A.	



Per fissaggio a pannello foro 24 mm.
Disponibile nei colori: nero, rosso e verde.

CCML VALVOLA A LEVA LATERALE -5 VIE-

COD. ART.	Filett.	Posiz.	PREZZO
CCML8F	1/8	C.A.P.	
CCML4F	1/4	C.A.P.	



Tipo a 3 posizioni stabili a centri aperti.
Disponibili anche instabili (senza F finale).
C.A.P.= centri aperti.

CCM VALVOLA A LEVA -5 VIE- 3 POS.

COD. ART.	Filett.	Posiz.	PREZZO
CCM8	1/8	C.A.P.	
CCM8F	1/8	C.A.P.	
CCM4F	1/4	C.A.P.	



Tipo a 3 posizioni stabili a centri aperti.
Disponibili anche instabili (senza F finale).
C.A.P.= centri aperti.

CQF AQF VALVOLA A FUNGO -3 VIE-

COD. ART.	Filett.	Posiz.	PREZZO
CQF8	1/8	N.C.	
AQF8	1/8	N.A.	



Per fissaggio a pannello foro 24 mm.
Disponibile nei colori: nero, rosso e verde.

EK VALVOLA A LEVA LATERALE -3 VIE-

COD. ART.	Filett.	Posiz.	PREZZO
EK8M	1/8	N.C.	
EK8MF	1/8	N.C.	
EK4M	1/4	N.C.	
EK4MF	1/4	N.C.	



Tipo con M finale = ritorno a molla.
Tipo con F finale = posizioni stabili.

EK VALVOLA A TIRETTO -3 VIE-

COD. ART.	Filett.	Posiz.	PREZZO
EK8T	1/8	N.C.	
EK8TF	1/8	N.C.	
EK4T	1/4	N.C.	
EK4TF	1/4	N.C.	



Tipo con T finale = ritorno a molla.
Tipo con F finale = posizioni stabili.

368 378 VALVOLA A LEVA LATERALE -5 VIE- 3 POS.

COD. ART.	Filett.	Posiz.	PREZZO
368900	1/8	C.CH.	
378900	1/8	C.A.P.	
368905*	1/8	C.CH.	
378905*	1/8	C.A.P.	

CAMOZZI

C.CH.= centri chiusi • C.A.P.= centri aperti.
*Tipi con 3 posizioni instabili.



EKCA VALVOLA A LEVA LATERALE -5 VIE-

COD. ART.	Filett.	Posiz.	PREZZO
EKCA8M	1/8	C.A.	
EKCA8MF	1/8	C.A.	
EKCA4M	1/4	C.A.	
EKCA4MF	1/4	C.A.	



Tipo con M finale = ritorno a molla.
Tipo con F finale = posizioni stabili.
C.A.= chiusa aperta.

EKCA VALVOLA A TIRETTO -5 VIE-

COD. ART.	Filett.	Posiz.	PREZZO
EKCA8T	1/8	C.A.	
EKCA8TF	1/8	C.A.	
EKCA4T	1/4	C.A.	
EKCA4TF	1/4	C.A.	



Tipo con T finale = ritorno a molla.
Tipo con F finale = posizioni stabili.
C.A.= chiusa aperta.



VALVOLE PNEUMATICHE ED ELETTROVALVOLE

3-97

FCP otturatore

VALVOLA MONOST. A PEDALE -3 VIE-

COD. ART.	Filett.	Posiz.	PREZZO
FCP8	1/8	N.C.	



①

CAP otturatore

VALVOLA BISTAB. A PEDALE -5 VIE-

COD. ART.	Filett.	Posiz.	PREZZO
CAP8F	1/8	C.A.	



① Disponibile anche monostabile.

PM1P

VALVOLA MONOST. A PEDALE ELETTR.

COD. ART.	Filett.	Posiz.	PREZZO
PM1P		Con fermo	
PM1ZP		Modello mini	
PE00*			



Elettrica

① *Interruttore di ricambio. Completa con blocco di sicurezza. Disponibile anche con più interruttori.

CP otturatore

VALVOLA MONOST. A PEDALE -3 VIE-

COD. ART.	Filett.	Posiz.	PREZZO
CP04	Ø 4	N.C.	
CPM5	M5	N.C.	



Mini

① CP04 = Completa di raccordi istantanei 4 mm

CAP otturatore

VALVOLA A PEDALE -5 VIE-

COD. ART.	Filett.	Posiz.	PREZZO
CAP4	1/4	C.A.	
CAP4F	1/4	C.A.	



① CAP4F = con fermo (bistabile)

CAP otturatore

VALVOLA A PEDALE -5 VIE-

COD. ART.	Filett.	Posiz.	PREZZO
CAP4P	1/4	C.A.	
CAP4FP	1/4	C.A.	
CAPBL		solo fermo	



① CAP4FP = con fermo (bistabile).

UK otturatore

VALVOLA 1 COMANDO PN. -3 VIE-

COD. ART.	Filett.	Posiz.	PREZZO
UKC812	1/8	N.C.	
UKC812SA	1/8	N.C.	
UKC416	1/4	N.C.	



① UKA812 1/8 N.A.
UKA416 1/4 N.A.
Disponibile anche con vite di regolazione.

UK otturatore

VALVOLA 1 COMANDO PN. -3 VIE-

COD. ART.	Filett.	Posiz.	PREZZO
UKC825	1/8	N.C.	
UKC432	1/4	N.C.	
UKC240	1/2	N.C.	



① UKA825 1/8 N.A.
UKA432 1/4 N.A.
UKA240 1/2 N.A.

UK otturatore

VALVOLA 1 COMANDO PN. -5 VIE-

COD. ART.	Filett.	Posiz.	PREZZO
UKCA8	1/8	C.A.	
UKCA4	1/4	C.A.	
UKCA2	1/2	C.A.	
UKCA8SA	1/8	C.A.	
UKCA4SA	1/4	C.A.	
UKCA2SA	1/2	C.A.	



① SA finale = servo alimentata.

ULCR otturatore

ELETTROVALV. PILOTA -3 VIE-

COD. ART.	Filett.	Posiz.	PREZZO
ULCRV	1/8	N.C.	
ULARV	1/8	N.A.	



① A richiesta: senza comando manuale.
24.00 - 24.50/60 - 110.50/60 - 220.50/60
12.00 Voltaggio speciale

UK otturatore

ELETTROVALVOLA -3 VIE-

COD. ART.	Filett.	Posiz.	PREZZO
UKC825U	1/8	N.C.	
UKC432U	1/4	N.C.	
UKC240U	1/2	N.C.	
UKA825U	1/8	N.A.	
UKA432U	1/4	N.A.	
UKA240U	1/2	N.A.	



① Solo valvola (senza parte elettrica).

UK otturatore

ELETTROVALVOLA -5 VIE-

COD. ART.	Filett.	Posiz.	PREZZO
UKCA8U	1/8	C.A.	
UKCA4U	1/4	C.A.	
UKCA2U	1/2	C.A.	
UKCA8U*	1/8	C.A.	
UKCA4U*	1/4	C.A.	
UKCA2U*	1/2	C.A.	



① * Completa di bobina e connettore.

ULCS otturatore

ELETTROVALV. PILOTA PER "UK"

COD. ART.	Filett.	Posiz.	PREZZO
ULCSV		N.C.	



① A richiesta: senza comando manuale.
24.00 - 24.50/60 - 110.50/60 - 220.50/60
12.00 Voltaggio speciale

ULP

BASE PER ELETTROVALV. PILOTA ULCSV

COD. ART.	Filett.	Uscite	PREZZO
ULP8S2	1/8	2	
ULP8S3	1/8	3	
ULP8S5	1/8	5	



① Adatta per montare in serie elettropiloti ULCSV.

CK

COLLETTORE PER VALVOLE "UK"

COD. ART.	Filett.	Uscite	PREZZO
CK82	1/8	2	
CK83	1/8	3	
CK85	1/8	5	
CK42	1/4	2	
CK43	1/4	3	
CK45	1/4	5	



①

EK spola

VALVOLA 1 COMANDO PN. -3 VIE-

COD. ART.	Filett.	Posiz.	PREZZO
EKC8KRZR	1/8	N.C.	
EKC4KRZR	1/4	N.C.	
EKA8KRZR	1/8	N.A.	
EKA4KRZR	1/4	N.A.	



① Disponibili anche modelli a molla pneumatica

EK spola

VALVOLA 1 COMANDO PN. -5 VIE-

COD. ART.	Filett.	Posiz.	PREZZO
EKCA8KRZR	1/8	C.A.	
EKCA4KRZR	1/4	C.A.	



① Disponibili anche modelli a molla pneumatica

EK spola

VALVOLA 2 COMANDI PN. -5 VIE-

COD. ART.	Filett.	Posiz.	PREZZO
EKCA8KRKR	1/8	C.A.	
EKCA4KRKR	1/4	C.A.	
EKCA8RSR	1/8	3P ch.	
EKCA4RSR	1/4	3P ch.	
EKCA8RAR	1/8	3P ap.	
EKCA4RAR	1/4	3P ap.	



① SR finale= centri chiusi / AR finale=centri aperti

EK spola

ELETTROVALV. MONOST. -3 VIE-

COD. ART.	Filett.	Posiz.	PREZZO
EKC8KUZR	1/8	N.C.	
EKC4KUZR	1/4	N.C.	
EKA8KUZR	1/8	N.A.	
EKA4KUZR	1/4	N.A.	



①

EK spola

ELETTROVALV. MONOST. -5 VIE-

COD. ART.	Filett.	Posiz.	PREZZO
EKCA8KUZR	1/8	C.A.	
EKCA4KUZR	1/4	C.A.	
EKCA8KUZR*	1/8	C.A.	
EKCA4KUZR*	1/4	C.A.	



① * Completa di bobina e connettore. Disponibili anche modelli a molla pneumatica

EK spola

ELETTROVALV. BISTAB. -5 VIE-

COD. ART.	Filett.	Posiz.	PREZZO
EKCA8KUKU	1/8	C.A.	
EKCA4KUKU	1/4	C.A.	
EKCA8SUSU	1/8	3P ch.	
EKCA4SUSU	1/4	3P ch.	
EKCA8UAU	1/8	3P ap.	
EKCA4UAU	1/4	3P ap.	



① Disponibili anche modelli a molla pneumatica

ULR

CONNETTORE PER ELETTROVALVOLA

COD. ART.	Tipo	PREZZO
ULR1	quadro PG11	
ULR2	rettang. PG09	
ULR1 leed	quadro PG11	
ULR2 leed	rettang. PG09	



① Tipo ULR1 per UK - Tipo ULR2 per EK
Protezione IP65 - A richiesta tipo stagno

USB

BOBINA PER ELETTROVALV. "EK"

COD. ART.	PREZZO
USB	



① 24.00 - 24.50/60 - 110.50/60 - 220.50/60
12.00 Voltaggio speciale

CEK

COLLETTORE PER VALVOLA "EK"

COD. ART.	Filett.	Uscite	PREZZO
CEK82	1/8	2	
CEK83	1/8	3	
CEK85	1/8	5	
CEK42	1/4	2	
CEK43	1/4	3	
CEK45	1/4	5	



① Adatta per montare in serie valvole "EK".

HDC	CILINDRO A CERNIERA SERIE -H-									
	CORSA	∅ 20	∅ 27	∅ 35	∅ 40	∅ 50	∅ 58	∅ 70	∅ 85	∅ 100
mm 20										
mm 25										
mm 30										
mm 35										
mm 50										
mm 60										
mm 70										
mm 100										
mm 150										
mm 200										
mm 250										
mm 300										
mm 400										
mm 500										
ingombro + corsa cilindro s.e.	mm 77 + corsa	mm 86 + corsa	mm 94 + corsa	mm 109 + corsa	mm 116 + corsa	mm 124 + corsa	mm 133 + corsa	mm 148 + corsa	mm 157 + corsa	

HDP	CILINDRO A PIEDINI SERIE -H-									
	CORSA	∅ 20	∅ 27	∅ 35	∅ 40	∅ 50	∅ 58	∅ 70	∅ 85	∅ 100
mm 20										
mm 25										
mm 30										
mm 35										
mm 50										
mm 60										
mm 70										
mm 100										
mm 150										
ingombro + corsa cilindro s.e.	mm 54 + corsa	mm 60 + corsa	mm 65 + corsa	mm 76 + corsa	mm 80 + corsa	mm 83 + corsa	mm 89 + corsa	mm 102 + corsa	mm 106 + corsa	

HDV	CILINDRO A MUSONE FILETTATO SERIE -H-									
	CORSA	∅ 20	∅ 27	∅ 35	∅ 40	∅ 50	∅ 58	∅ 70	∅ 85	∅ 100
mm 20										
mm 25										
mm 30										
mm 35										
mm 50										
mm 60										
mm 70										
mm 100										
mm 150										
ingombro + corsa cilindro s.e.	mm 44 + corsa	mm 49 + corsa	mm 51 + corsa	mm 54 + corsa	mm 59 + corsa	mm 63 + corsa	mm 67 + corsa	mm 71 + corsa	mm 76 + corsa	

HDF A	CILINDRO A FLANGIA ANTERIORE SERIE -H-									
	CORSA	∅ 20	∅ 27	∅ 35	∅ 40	∅ 50	∅ 58	∅ 70	∅ 85	∅ 100
mm 20										
mm 25										
mm 30										
mm 35										
mm 50										
mm 60										
mm 70										
ingombro + corsa cilindro s.e.	mm 58 + corsa	mm 67 + corsa	mm 73 + corsa	mm 83 + corsa	mm 88 + corsa	mm 92 + corsa	mm 98 + corsa	mm 112 + corsa	mm 122 + corsa	

HDF P	CILINDRO A FLANGIA POSTERIORE SERIE -H-									
	CORSA	∅ 20	∅ 27	∅ 35	∅ 40	∅ 50	∅ 58	∅ 70	∅ 85	∅ 100
mm 20										
mm 25										
mm 30										
mm 35										
mm 50										
mm 60										
mm 70										
ingombro + corsa cilindro s.e.	mm 70 + corsa	mm 79 + corsa	mm 89 + corsa	mm 97 + corsa	mm 99 + corsa	mm 106 + corsa	mm 113 + corsa	mm 127 + corsa	mm 140 + corsa	

Esempio di ordinazione cilindri:

HDC 50/70 - HDC 50150

Per il diametro mm 100 indicare 99

SERIE GUARNIZIONI RICAMBIO

DISPONIBILITA' PERNO CERNIERA

CORSE BASE CILINDRI SERIE -H-

KG DI SPINTA TEORICI A 6 BAR

		RICAMBI E DATI RELATIVI AI CILINDRI SERIE -H-									
CODICE		∅ 20	∅ 27	∅ 35	∅ 40	∅ 50	∅ 58	∅ 70	∅ 85	∅ 100	
HB .. SG					*	*		*		*	
SEC ..											
		20	25	35	60	70	60	70	100	100	
		18	34	57	75	118	158	231	340	471	

Disponibili a richiesta con canna ottone • Asta passante • Stelo inox • Molla traente • Guarnizioni per alte temperature • Nel cilindro s.e. corse diverse dalla corsa base

UDC-UDE-USC	-UDC- DOPPIO EFFETTO				-UDE- DOPPIO EFFETTO MAGNETICO				-USC- SEMPLICE EFFETTO				
	CORSA	∅ 12	∅ 16	∅ 20	∅ 25	∅ 12	∅ 16	∅ 20	∅ 25	∅ 12	∅ 16	∅ 20	∅ 25
mm 10													
mm 20													
mm 25													
mm 30													
mm 40													
mm 50													
mm 60													
mm 80													
mm 100													
kg spinta-6 bar	6	12	18	29	6	12	18	29	6	12	18	29	

 ① Disponibili con diametro 8-10 mm • Regolatori di fine corsa • Stelo passante • Antirotazione • Corse diverse da quelle indicate

CDB	CILINDRO CORSA BREVE -DOPPIO EFFETTO-										
	CORSA	∅ 12	∅ 16	∅ 20	∅ 25	∅ 32	∅ 40	∅ 50	∅ 63	∅ 80	∅ 100
mm 10											
mm 20											
mm 25											
mm 30											
mm 40											
mm 50											
mm 60											
mm 80											
mm 100											
CDB .. SG											
kg spinta-6 bar	6	12	18	29	44	69	110	178	291	458	

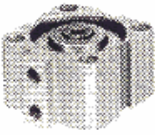
 ① Disponibili con diametro 10 mm • Antirotazione • Stelo passante • Predisposizione fine corsa magnetici • Corse diverse da quelle indicate

CSB	CILINDRO CORSA BREVE -SEMPLICE EFFETTO-										
	CORSA	∅ 12	∅ 16	∅ 20	∅ 25	∅ 32	∅ 40	∅ 50	∅ 63	∅ 80	∅ 100
mm 10											
mm 25											
mm 30											
mm 40											
mm 50											
CSB .. SG											
kg spinta-6 bar	6	12	18	29	44	69	110	178	291	458	

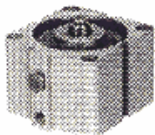
 ① Disponibili con diametro 10 mm • Antirotazione • Corse diverse da quelle indicate • Molla anteriore

CPI	-CPU/M- CILINDRO A NORME ISO MAGNETICO -DOPPIO EFFETTO-									
	CORSA	∅ 32	∅ 40	∅ 50	∅ 63	∅ 80	∅ 100	∅ 125	∅ 160	∅ 200
mm 25										
mm 50										
mm 75										
mm 100										
mm 125										
mm 150										
mm 200										
mm 250										
mm 300										
mm 400										
mm 500										
mm 600										
mm 800										
mm 1000										
CPI .. SG										
kg spinta-6 bar		44	69	110	178	291	458	721	1186	1861

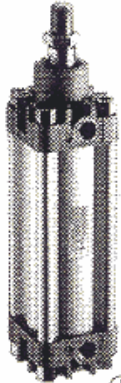
 ① Disponibili con sistema antirotazione • Stelo passante • Senza predisposizione f. c. magnetici • Stelo inox • Per alte temperature • Corse diverse da quelle indicate

CPU-CX	-CPU/CX- CILINDRO A NORME CETOP O CNOMO -DOPPIO EFFETTO-									
	CORSA	∅ 32	∅ 40	∅ 50	∅ 63	∅ 80	∅ 100	∅ 125	∅ 160	∅ 200
mm 25										
mm 50										
mm 75										
mm 100										
mm 125										
mm 150										
mm 200										
mm 250										
mm 300										
mm 400										
mm 500										
mm 600										
mm 800										
mm 1000										
CPU .. SG										

 ① Disponibili con sistema antirotazione • Stelo passante • Stelo inox • Tiranti inox • Canna acciaio, ottone • Per alte temperature • Corse diverse da quelle indicate

ACCESSORI PER CILINDRI PNEUMATICI

3-97

UP **PIEDINO PER CILINDRI SERIE "U"**

COD. ART.	alesaggio	PREZZO
UP0810	8-10 mm	
UP1216	12-16 mm	
UP2025	20-25 mm	

PA **PIEDINO ALTO CPU-CX**

COD. ART.	alesaggio	PREZZO
PA32	32 mm	
PA40	40 mm	
PA50	50 mm	
PA63	63 mm	
PA80	80 mm	
PA99	100 mm	

CI **CERNIERA INTERMEDIA**

COD. ART.	alesaggio	PREZZO
CI32	32 mm	
CI40	40 mm	
CI50	50 mm	
CI63	63 mm	
CI80	80 mm	
CI99	100 mm	

UF **FLANGIA PER CILINDRI SERIE "U"**

COD. ART.	alesaggio	PREZZO
UF0810	8-10 mm	
UF1216	12-16 mm	
UF2025	20-25 mm	

PB **PIEDINO BASSO ISO**

COD. ART.	alesaggio	PREZZO
PB32	32 mm	
PB40	40 mm	
PB50	50 mm	
PB63	63 mm	
PB80	80 mm	
PB99	100 mm	

Modello CCC. - Il prezzo è riferito alla coppia.

SEC **PERNO CERNIERA ISO**

COD. ART.	alesaggio	PREZZO
SEC32	32 mm	
SEC40	40 mm	
SEC50	50 mm	
SEC63	63 mm	
SEC80*	80 mm	
SEC99*	100 mm	

*Per cilindro serie CPU.

UC **SUPPORTO PER CILINDRI SERIE "U"**

COD. ART.	alesaggio	PREZZO
UC0810	8-10 mm	
UC1216	12-16 mm	
UC2025	20-25 mm	

FL **FLANGIA ISO**

COD. ART.	alesaggio	PREZZO
FL32	32 mm	
FL40	40 mm	
FL50	50 mm	
FL63	63 mm	
FL80	80 mm	
FL99	100 mm	

Modello CCC.

DA **DADO STELO CILINDRI ISO**

COD. ART.	filetto	PREZZO
DA10	M10 x 1,25	
DA12	M12 x 1,25	
DA16	M16 x 1,5	
DA20	M20 x 1,5	

FPF **FORCELLA PER CILINDRI UNI-DIN**

COD. ART.	filetto	PREZZO
FPF04	M4	
FPF06	M6	
FPF08	M8	
FPF10	M10	
FPF12	M12	
FPF14	M14	
FPF16	M16	
FPF18	M18	
FPF20	M20	

CFC **CERNIERA FEMMINA ISO**

COD. ART.	alesaggio	PREZZO
CFC32	32 mm	
CFC40	40 mm	
CFC50	50 mm	
CFC63	63 mm	
CFC80	80 mm	
CFC99	100 mm	

BOCCOLE BRONZO
Modello CCC.

GSS **GIUNTO SNODATO**

COD. ART.	filetto	PREZZO
GSS06	M6 x 1	
GSS08	M8 x 1,25	
GSS10	M10 x 1,25	
GSS12	M12 x 1,25	
GSS16	M16 x 1,5	
GSS20	M20 x 1,5	

A richiesta: M4x0,7 - M10x1,5 - M12x1,75

FFF **FORCELLA PER CILINDRI ISO-CETOP**

COD. ART.	filetto	PREZZO
FFF10	M10 x 1,25	
FFF12	M12 x 1,25	
FFF16	M16 x 1,5	
FFF20	M20 x 1,5	

CF **CERNIERA FEMMINA ISO**

COD. ART.	alesaggio	PREZZO
CF32	32 mm	
CF40	40 mm	
CF50	50 mm	
CF63	63 mm	
CF80*	80 mm	
CF99*	100 mm	

*Per cilindro serie CPU.

FCM-FEK **FINE CORSA MAGNETICO PER CILINDRI A SPINA SMONTABILE**

COD. ART.	descrizione	PREZZO
FCM*	completo	
FEK	come da fig.	

*Completo di ogni supporto per cilindri da 12 a 100 mm.

FFX **FORCELLA PER CILINDRI CX**

COD. ART.	filetto	PREZZO
FFX10	M10 x 1,25	
FFX16	M16 x 1,5	
FFX20	M20 x 1,5	
FFX27	M27 x 2	

CM **CERNIERA MASCHIO ISO**

COD. ART.	alesaggio	PREZZO
CM32	32 mm	
CM40	40 mm	
CM50	50 mm	
CM63	63 mm	
CM80*	80 mm	
CM99*	99 mm	

*Per cilindro serie CPU.

FCM-FFV **FINE CORSA MAGNETICO PER CILINDRI/MICROCILINDRI**

COD. ART.	descrizione	PREZZO
FCM*	completo	
FFV	come da fig.	

*Completo di ogni supporto per cilindri da 12 a 100 mm.

CLI **CLIPS DI RICAMBIO**

COD. ART.	filetto	PREZZO
CLI06	M6	
CLI08	M8	
CLI10	M10	
CLI12	M12	
CLI14	M14	
CLI16	M16	
CLI18	M18	
CLI20	M20	

CN **CERNIERA NORMALE ISO**

COD. ART.	alesaggio	PREZZO
CN32	32 mm	
CN40	40 mm	
CN50	50 mm	
CN63	63 mm	
CN80	80 mm	
CN99	100 mm	

FCM-FGV **FINE CORSA MAGNETICO PER MICROCILINDRI 8-25**

COD. ART.	descrizione	PREZZO
FCM*	completo	
FGV	come da fig.	

*Completo di ogni supporto per cilindri da 12 a 100 mm.

FSS **FORCELLA A SNODO SFERICO**

COD. ART.	filetto	PREZZO
FSS06	M6 x 1	
FSS08	M8 x 1,25	
FSS10	M10 x 1,5	
FSS12	M12 x 1,25	
FSS16	M16 x 1,5	
FSS20	M20 x 1,5	

AS **ARTICOLAZIONE A SQUADRA ISO**

COD. ART.	alesaggio	PREZZO
AS32	32 mm	
AS40	40 mm	
AS50	50 mm	
AS63	63 mm	
AS80*	80 mm	
AS99*	100 mm	

*Per cilindro serie CPU.

COD. ART.	DESCRIZIONE	PREZZO
FA23	Supporto plastica per micro cilindri serie "U" 8-25 mm	
FA47	Distanziale plastica per cilindri "ISO" 32-100 mm	
FA48	Supporto metall. con distanziale FA47 per cil. "ISO" 32-100 mm	
FA49	Supporto regolabile per cilindri a tirante "CPU" 32-100 mm	

A

VERTICALE

COD. ART.	perno filett.	PREZZO
A070	M5	
A125	M6	
A200	M8	
A300	M10	
A400	M12	
A500	M12	
STANDARD		

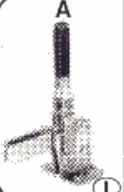

AS

A SPINTA E TRAZIONE

COD. ART.	perno filett.	PREZZO
AS075	M6	
AS150	M8	
AS310	M10	
30075	supporto	
30150	supporto	
30310	supporto	



APV

VERTICALE PNEUMATICO

COD. ART.	perno filett.	PREZZO
APV200	M8	
APV300	M10	



AV

VERTICALE

COD. ART.	perno filett.	PREZZO
AV200	M8	
AV300	M10	



TF

A TIRANTE

COD. ART.	PREZZO
TF200	
TF300	
TF400	



EPV

VERTICALE PNEUMATICO

COD. ART.	PREZZO
EPV1000	
EPV2000	

serie pesante



F

VERTICALE PESANTE

COD. ART.	PREZZO
F1000	
F2000	
F3000	

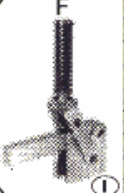

T2

A DOPPIO TIRANTE

COD. ART.	PREZZO
T2/160	
T2/320	
T2/700	



ASM - ASP

A SPINTA PNEUMATICO

COD. ART.	perno filett.	PREZZO
ASM070*	M6	
ASP350	M8	
ASP1000	M10	
ASP2000	M12	

* predisposto per fine corsa magnetici



M

ORIZZONTALE

COD. ART.	perno filett.	PREZZO
M025	M4	
M070	M5	
M115	M6	
M220	M8	
M350	M10	
M450	M12	
STANDARD		

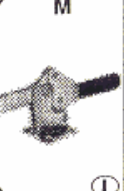

T2

A TIRANTE - PESANTE

COD. ART.	PREZZO
T2/1400	
T2/2800	



PERNO CON TESTA NEOPRENE

COD. ART.	perno filett.	PREZZO
10140	M5	
10141	M6	
10142	M8	
10143	M10	



ASD - ASS

A SPINTA E TRAZIONE

COD. ART.	perno filett.	PREZZO
ASD50	M4	
ASS50	M4	

ASD = a spinta destro
ASS = a spinta sinistro



T3

A DOPPIO TIRANTE

COD. ART.	PREZZO
T3/160	
T3/320	
T3/700	



PERNO ESAGONALE

COD. ART.	perno filett.	PREZZO
10100	M5	
10101	M6	
10102	M8	
10102	M10	
10104	M12	
10105	M12	



ASD - ASS

A SPINTA E TRAZIONE

COD. ART.	perno filett.	PREZZO
ASD70	M6	
ASD160	M6	
ASD70	M6	
ASS160	M6	

ASD = a spinta destro
ASS = a spinta sinistro

serie pesante



T4

A DOPPIO TIRANTE

COD. ART.	PREZZO
T4/160	
T4/320	
T4/700	



PERNO SNODATO

COD. ART.	perno filett.	PREZZO
10120	M5	
10121	M6	
10122	M8	
10123	M10	
10124	M12	
10125	M12	



AS

A SPINTA

COD. ART.	perno filett.	PREZZO
AS120	M6	
AS300	M8	



AP3 - AP2

VERTICALE PNEUMATICO

COD. ART.	perno filett.	PREZZO
AP3/070*	M5	
AP2/125	M6	
AP2/200	M8	
AP2/300	M10	
AP2/400	M12	

* Predisposto per fine corsa magnetici

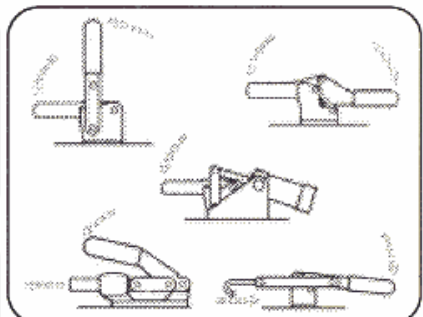



AS

A SPINTA E TRAZIONE

COD. ART.	perno filett.	PREZZO
AS070	M6	
AS160	M6	
AS350	M8	
AS1000	M10	
AS2000	M12	
AS3000	M14	

serie pesante



EP

VERTICALE PNEUMATICO

COD. ART.	PREZZO
EP1000	
EP2000	

serie pesante



N.B.: Il numero nei COD.ART. alfanumerici è da considerarsi come Kg di resistenza della struttura alla deformazione.
Es.: A070 = 70 Kg di resistenza

MULTIPLICATORI DI PRESSIONE E CILINDRI IDRAULICI

MULTIPLICATORE PRESSIONE ARIA/OLIO - 100

Alesaggio mm 100

COD. ART.	RAPP. PRESS.	EROG. CM ³	PREZZO
100.16.05RM	1-39	12	
100.18.05RM	1-30	15	
100.20.05RM	1-25	18	
100.22.05RM	1-20	22	
100.16.05RP	1-39	12	
100.16.10RP	1-39	20	
100.16.15RP	1-39	30	
100.18.05RP	1-30	15	
100.18.10RP	1-30	25	
100.18.15RP	1-30	38	
100.20.05RP	1-25	18	
100.20.10RP	1-25	32	
100.20.15RP	1-25	47	
100.22.05RP	1-20	22	
100.22.10RP	1-20	38	
100.22.15RP	1-20	57	

RM= ritorno a molla
RP= ritorno pneum.

CILINDRO ESTERNO FILETTATO

COD. ART.	OLIO CM ³	AREA CM ²	PREZZO
20.14.05	0,76	1,53	
20.14.15	2,30	1,53	
20.14.25	3,80	1,53	
30.22.05	1,80	3,80	
30.22.15	5,70	3,80	
30.22.25	9,50	3,80	
36.18.15	9,20	6,15	
36.18.25	15,40	6,15	
40.18.15	12,00	8,03	
40.18.25	20,00	8,03	
48.18.25	26,80	10,74	
48.18.50	53,60	10,74	
68.25.25	63,80	25,50	
68.25.50	127,60	25,50	

ritorno a molla

CILINDRO ESTERNO FILETTATO

COD. ART.	OLIO CM ³	AREA CM ²	PREZZO
36.25.25	12,25	4,90	
36.25.50	24,50	4,90	
36.25.80	39,20	4,90	
36.25.100	49,00	4,90	
48.35.25	24,05	9,62	
48.35.50	48,10	9,62	
48.35.80	76,96	9,62	
48.35.100	96,20	9,62	
68.55.50	118,75	23,75	
68.55.80	190,99	23,75	
68.55.100	237,50	23,75	

DOPPIO EFFETTO

I dati riportati del volume olio e area del pistone SONO IN SPINTA.
I dati in trazione vanno intesi diminuiti di circa il 20-30%. Consultateci!

MULTIPLICATORE PRESSIONE ARIA/OLIO - 160

Alesaggio mm 160

COD. ART.	RAPP. PRESS.	EROG. CM ³	PREZZO
160.25.05RM	1-41	24	
160.25.15RM	1-41	74	
160.32.05RM	1-25	40	
160.32.15RM	1-25	120	
160.35.05RM	1-21	48	
160.35.15RM	1-21	144	
160.25.05RP	1-41	22	
160.25.15RP	1-41	71	
160.32.05RP	1-25	36	
160.32.15RP	1-25	116	
160.35.05RP	1-21	43	
160.35.15RP	1-21	139	

RM= ritorno a molla
RP= ritorno pneum.

CILINDRO FORO PASSANTE LISCIO - EST. LISCIO

COD. ART.	OLIO CM ³	AREA CM ²	PREZZO
50.40.06	6,01	10,02	
70.57.06	12,36	20,97	
70.57.12	24,72	20,97	
85.70.06	19,38	32,33	
85.70.12	38,76	32,33	

ritorno a molla

VALVOLA DI SEQUENZA

COD. ART.	campo di sequenza BAR	PREZZO
VS.40.60	50 - 150	
VS.50.70	40 - 125	

Queste valvole servono per ritardare l'inserimento di uno o più cilindri rispetto ad altri, mentre il ritorno degli stessi rimane contemporaneo agli altri.

MULTIPLICATORE PRESSIONE ARIA/OLIO - 200

Alesaggio mm 200

COD. ART.	RAPP. PRESS.	EROG. CM ³	PREZZO
200.25.05RM	1-64	34	
200.25.15RM	1-64	73	
200.28.05RM	1-51	43	
200.28.15RM	1-51	92	
200.32.05RM	1-39	56	
200.32.15RM	1-39	120	
200.35.05RM	1-32	67	
200.35.15RM	1-32	144	
200.40.05RM	1-25	87	
200.40.15RM	1-25	187	
200.25.05RP	1-64	27	
200.25.15RP	1-64	66	
200.28.05RP	1-51	34	
200.28.15RP	1-51	83	
200.32.05RP	1-39	44	
200.32.15RP	1-39	108	
200.35.05RP	1-32	53	
200.35.15RP	1-32	130	
200.40.05RP	1-25	69	
200.40.15RP	1-25	169	

RM= ritorno a molla
RP= ritorno pneum.

CILINDRO FORO PASSANTE FILETT. - EST. FILETT.

COD. ART.	OLIO CM ³	AREA CM ²	PREZZO
48.40.06	6,01	10,02	
68.57.06	12,36	20,97	
68.57.12	24,72	20,97	
83.70.06	19,38	32,33	
83.70.12	38,76	32,33	

ritorno a molla

RIPARTITORE DI DISTRIBUZIONE

COD. ART.	Filettatura	PREZZO
CD.40.60	4 uscite 1/8	
CD.40.90	5 uscite 1/8	

L'entrata è filettata da 3/8

CILINDRO MONOBLOCCO - RITORNO A MOLLA

COD. ART.	OLIO CM ³	AREA CM ²	PREZZO
35.20.15	2,30	1,53	
45.30.15	5,70	3,79	
55.36.15	9,25	6,15	
65.40.15	12,00	8,03	
75.48.25	26,80	10,74	
85.68.25	63,80	25,50	

ritorno a molla

BASE QUADRA DI SUPPORTO

COD. ART.	Filettatura	PREZZO
BQ.36	M 36 x 1,5	
BQ.48	M 48 x 1,5	
BQ.68	M 68 x 2,0	

MULTIPLICATORE PRESSIONE OLIO/OLIO - 100

COD. ART.	RAPP. PRESS.	EROG. CM ³	PREZZO
100.70.1.2	1-2	230	
100.50.1.4	1-4	117	
100.45.1.5	1-5	95	
100.35.1.8	1-8	57	
100.32.1.10	1-10	48	

ritorno a molla

CILINDRO A STAFFA ROTANTE DI 90°

COD. ART.	OLIO CM ³	AREA CM ²	PREZZO
36.14.06DX	7,56	4,2	
48.20.08DX	15,00	6,5	
36.14.06SX	7,56	4,2	
48.20.08SX	15,00	6,5	

ritorno a molla

GHIERA DI FISSAGGIO

COD. ART.	Filettatura	PREZZO
GF.20	M 20 x 1,5	
GF.30	M 30 x 1,5	
GF.36	M 36 x 1,5	
GF.40	M 40 x 1,5	
GF.48	M 48 x 1,5	
GF.68	M 68 x 2,0	

POMPA OLEOPNEUMATICHE ARIA/OLIO - 160

COD. ART.	RAPP. PRESS.	EROG. CM ³	PREZZO
160.24.36	1-24	36	
160.40.22	1-40	22	

doppio effetto
ritorno pneum.

CILINDRO PER BLOCCO A MOLLE - SBLOCCO IDR.

COD. ART.	OLIO CM ³	AREA CM ²	PREZZO
48.CK.11	2,3	8,20	
68.CK.25	5,3	14,20	

ritorno a molla

PUNTALI

COD. ART.	M = filetto L = lunghezza	PREZZO
PR.13.06	M 6 - L 20	
PC.13.06	M 6 - L 25	
PV.13.06	M 6 - L 20	
PR.17.08	M 8 - L 27	
PC.17.08	M 8 - L 32	
PV.17.08	M 8 - L 27	

LUBRIFICAZIONE FORZATA OLIO-GRASSO

9-97

DOC DOS **DOSATORE OLIO TERMINALE**

COD. ART.	MISURA	PREZZO
DOC compl.	1/8 - 4	
DOS	1/8 - 5/16	

DOC= con dado e bicono - DOS= come fig.

1=A circa 5 gocce al minuto
2=B circa 10 gocce al minuto
3=C circa 18 gocce al minuto
Con olio 45E, a 50°C



DOD DOR **DOSATORE OLIO PER RIPART.**

COD. ART.	MISURA	PREZZO
DOD compl.	5/16 - 4	
DOR	5/16 - 5/16	

DOD= con dado e bicono - DOR= come fig.

1=A circa 5 gocce al minuto
2=B circa 10 gocce al minuto
3=C circa 18 gocce al minuto
Con olio 45E, a 50°C



RAC RAD **RACCORDO**

COD. ART.	MISURA	PREZZO
RAC compl.	1/8 - 4	
RAD	1/8 - 5/16	

RAC= con dado e bicono come figura
RAD= solo parte inferiore figura



BIC **OGIVA - BICONO**

COD. ART.	MISURA	PREZZO
BIC	4 mm	



DAD **DADO PER DOSATORE**

COD. ART.	MISURA	PREZZO
DAD	5/16 - 4	



RAF **RACCORDO PER RIPART.**

COD. ART.	MISURA	PREZZO
RAF	5/16 - 4	



TAP **TAPPO PER RIPARTITORE**

COD. ART.	MISURA	PREZZO
TAP	5/16	



RXX **RIPARTITORE -4 VIE-**

COD. ART.	MISURA	PREZZO
RXX	5/16	

Per ridurre le vie utilizzare TAP.



R **RIPARTITORE MULTIPLO 5/16**

COD. ART.	Nr. Vie	PREZZO
R22	2+2	
R32	3+2	
R42	4+2	
R52	5+2	
R62	6+2	
R82	8+2	
R102	10+2	



JM **POMPA OLIO A MANIGLIA**

COD. ART.	MISURA	PREZZO
JM1	serb. lt 0,4	
JM2	serb. lt 1,2	
JM3	serb. lt 1,2	

Portata fissa 6 cm³ per colpo
Portata fissa 9 cm³ per colpo
Portata fissa 18 cm³ per colpo
Pressione 3,5 bar - JM3= 3 bar



JM **POMPA OLIO A LEVA**

COD. ART.	MISURA	PREZZO
JM4	serb. lt 1,2	
JM5	serb. lt 1,2	

Portata regolabile 3-9 cm³ per colpo
Portata regolabile 6-18 cm³ per colpo
JM4= max 3,5 bar - JM5= max 3 bar



FT **STAFFETTA FISSATUBO 4 mm**

COD. ART.	MISURA	PREZZO
FT1	1 posiz.	
FT2	2 posiz.	
FT3	3 posiz.	
FT4	4 posiz.	
FT5	5 posiz.	
FT6	6 posiz.	

Posiz.= numero tubi fissabili.



POD **ELETTRO-POMPA OLIO**

COD. ART.	MISURA	PREZZO
POD	serb. lt 1,7	

Con led di segnalazione livello del minimo
Pressione max 4 bar.
Voltaggi 24/50-110/50-220/50 volt.
Cicli lubrificazione temporizzata a richiesta: 5'-10'-30'-60'-120'



JVT **ELETTRO-POMPA OLIO**

COD. ART.	MISURA	PREZZO
JVT 24/50 v.	serb. lt 2,7	
JV2 220/50 v.	serb. lt 2,7	

Con segnalazione livello del minimo
Pressione max 4 bar.
Voltaggi 24/50-110/50-220/50 volt.
Cicli lubr. temp. programmabile da 4' a 90' con interventi da 2 a 30 sec.



ELO **ELETTRO-POMPA OLIO**

COD. ART.	MISURA	PREZZO
ELO	serb. lt 2-9	

Pressione max 28 bar.
Voltaggio 220/380 volt-50 Hz.
Cicli di lubrificazione temporizzata programmabile da 50 sec. a 60 minuti.



TED **TEMPORIZZATORE PROGRAMM.**

COD. ART.	MISURA	PREZZO
TED	77 x 94 mm	

Cicli programmabili da 0 a 24 ore con interventi da 0-40 secondi.
Utilizzabile anche per usi generici e per pompa PPN.



TEM **TEMPORIZZATORE PROGRAMM.**

COD. ART.	MISURA	PREZZO
TEM	40 x 70 mm	

Cicli programmabili da 4 a 90 minuti con interventi da 2-30 sec. + manuale.
Utilizzabile per usi generici, pompa PPN, e ricambio pompa JVT.



PPN **POMPA OLIO-COMANDO PNEUMATICO**

COD. ART.	MISURA	PREZZO
PPN	serb. lt 0,8	

Portata per ogni azionamento 15 cm³.
Rapporto pressione comando-utilizzo 1-1.
Possibilità di comando a olio.



PG **POMPA GRASSO MANUALE**

COD. ART.	Capacità	PREZZO
PG5	500 gr	
PG7	750 gr	
PG9	1000 gr	
PGR	test. ric.	
PGT tubo	400 mm	

Completa di tubo alta press. e testina.



PGP **POMPA GRASSO PNEUMATICA**

COD. ART.	Capacità	PREZZO
PGP	1000 gr	
PGR	test. ric.	
PGT tubo	400 mm	

Completa di tubo alla press. e testina.
A richiesta: mod. per cartuccia grasso 600 gr.



ZM **POMPA GRASSO-COMANDO A LEVA**

COD. ART.	MISURA	PREZZO
ZM2	2 lt	
ZM5	5 lt	

Pressione di esercizio regolabile da 50 a 200 bar.
A richiesta: modello per olio.



PGL **POMPA GRASSO MANUALE**

COD. ART.	MISURA	PREZZO
PGL		

Completa di tubo alta pressione, rubinetto e testina a griffe.
Adatta per grasso in fusti.
A richiesta: modello per olio.



PGC **POMPA GRASSO PNEUMATICA**

COD. ART.	MISURA	PREZZO
PGC		

Completa di tubo alta pressione, pistola e testina a griffe.
Adatta per grasso in fusti.
A richiesta: modello per olio.



KPM **SPRUZZATORE OLIO NEBULIZZATO**

COD. ART.	MISURA	PREZZO
KPM		

Larghezza 25 mm
Altezza 30 mm (esclusa vite di regolaz.)
Filettatura M5 - Racordi a richiesta
Spruzzatore nebulizzatore sistema "Venturi".



ANTIVIBRANTI IN GOMMA

MM	ANTIVIBRANTI IN GOMMA				
	MISURA e COD. ART.	Filetto MA mm.	Kg. con carico a: compress. - taglio		PREZZO
	1210	5	15	2	
	1515	4	20	4	
	2010	6	50	4	
	2015	6	50	4	
	2020	6	40	3	
	2025	6	30	3	
	2515	6	50	6	
	2520	6 - 8	60	6	
	2530	6 - 8	40	4	
	3020	8	90	10	
	3030	8	80	8	
	3038	8	65	6	
	4030	8 - 10	120	16	
	4035	8	100	14	
	4040	8	140	14	
	5020	10	220	22	
	5030	10	200	20	
	5040	10	170	18	
	5045	10	160	17	
	5050	10	150	14	
	6050	12	230	25	
	6535	12	400	60	
	6550	12	350	30	
	7525	12	500	90	
	7540	12	480	80	
	7550	12	900	70	
	9940	16	900	100	
	9950	16	850	100	
	9955	16	800	80	
	9960	16	700	50	

Primi due numeri del codice= diametro Secondi due numeri= altezza
L'altezza è intesa senza perni filett. **Esempio d'ordine: MM1210**

AS	ANTIVIBRANTE SGOLATO				
	MISURA e COD. ART.	Filetto MA e Dimensioni	Kg. con carico a: compress. - taglio		PREZZO
	AS12	4 12d-15h	2 - 3	0,8	
	AS24	6 24d-20h	10 - 20	3	
	AS39	8 40d-30h	15 - 28	6	
	AS41	8 40d-30h	30 - 60	12	

d= diametro h= altezza (escluso perno)

PA-PS	ANTIVIBRANTE A PAVIMENTO				
	COD. ART.	Filetto MA e Dimensioni	Kg. a compress. con carico statico		PREZZO
	PA80	10 80x80	450		
	PA120	12 120x120	900		
	PS80*	80x80	450		
	PS120*	120x120	900		

* Senza perno

AL	ANTIVIBRANTE PER MACCHINE UTENSILI - LEGGERO				
	COD. ART.	Filetto MA e Dimensioni	Kg. a compress. statico dinamico		PREZZO
	120	12 80d-27h	900	320	
	120/1	14 110d-32h	1500	550	
	121	16 140d-39h	2000	750	
	122	20 200d-62h	3600	1450	

d= diametro h= altezza (escluso perno)

AL	ANTIVIBRANTE PER MACCHINE UTENSILI - PESANTE				
	COD. ART.	Filetto MA e Dimensioni	Kg. a compress. statico dinamico		PREZZO
	AL08	12 80d-27h	1200	400	
	AL11	14 110d-32h	1900	650	
	AL14	16 140d-39h	2850	900	
	AL20	20 200d-62h	6000	1800	

d= diametro h= altezza (escluso perno)

PM	ANTIVIBRANTE A PAVIMENTO				
	MISURA e COD. ART.	Filetto MA mm.	Kg. a compress. con carico statico		PREZZO
	PM1515	4	20		
	PM2015	6	50		
	PM2515	6	50		
	PM2520	6	60		
	PM3020	8	90		
	PM3030	8	80		
	PM4030	8	100		
	PM4040	8	75		
	PM5020	10	160		
	PM5030	10	200		
	PM6050	12	230		
	PM7525	12	450		
	PM7540	12	400		
	PM7550	12	350		
	PM9950	16	650		

Primi due numeri del codice= diametro Secondi due numeri= altezza
L'altezza è intesa senza perni filett.

AV	ANTIVIBRANTE E PARACOLPI				
	MISURA e COD. ART.	Filetto MA e Dimensioni	Kg. a compress. con carico statico		PREZZO
	AV25	6 25d-30h			
	AV30	8 30d-40h			
	AV40	8 40d-50h			
	AV50	10 50d-55h			
	AV75	12 75d-70h			
	AV99	16 99d-85h			

d= diametro h= altezza

AS	ANTIVIBRANTE UNIVERSALE				
	COD. ART.	Filetto MA e Dimensioni	Kg. a compress. con carico statico		PREZZO
	100	12 105d-53h	650-950		

d= diametro (interasse da foro a foro) h= altezza (escluso perno)
La larghezza è 75 mm.

PA-PS	ANTIVIBRANTE UNIVERSALE ALLUNGATO				
	COD. ART.	Filetto MA e Dimensioni	Kg. a compress. con carico statico		PREZZO
	101	12 85d-46h	500		
	102	12 135d-46h	1200		
	103	12 185d-46h	1400		
	104	12 235d-46h	1600		

d= diametro (interasse da foro a foro) h= altezza (escluso perno)
La larghezza è 60 mm.

AL	ANTIVIBRANTE ELASTICO A CAMPANA				
	COD. ART.	Filetto MA e Dimensioni	Kg. a compress. con carico statico		PREZZO
	105	85d-30h	200		
	106	110d-45h	350		
	107	160d-50h	600		
	105CD	10 85d-30h	200		
	106CD	16 110d-45h	350		
	107CD	24 160d-50h	600		

CD= con dado filett. d= diametro (interasse da foro a foro) h= altezza

BA	ANTIVIBRANTE IN BARRA			
	COD. ART.	Dimensioni	Lunghezza	PREZZO
	BA50	50d 50h	1000	
	BA60	60d 60h	1000	
	BA70	70d 60h	1000	
	BA80	80d 60h	1000	
	BA99	100d 60h	1000	

Carico di circa 14 Kg/cm² Gomma compressa tra due piastre metall.
d= diametro h= altezza

POMPE VUOTO e ACCESSORI

9-97

HR

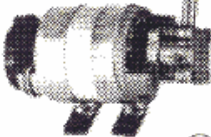

MINIPOMPA VUOTO

vol. asp.	PREZZO
0,8 mc/h	
H25R	

① Vuoto + pressione 2 bar.

VTL



POMPA VUOTO

HP	PREZZO
0,20	
0,35	
0,75	
1,2	
1,5	
2	

① A secco o bagno d'olio.

VTB

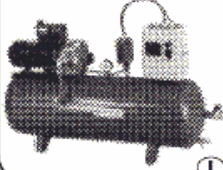

POMPA VUOTO

Serb. lt	PREZZO
50	
100	
150	
300	
500	

① Pompa rotativa a palette lubr. Stadi: mono o doppio.

ZH



GENERATORE VUOTO

COD. ART.	∅ Fil.	PREZZO
ZH07B	07 6-1/8	
ZH10B	1,0 6-1/8	
ZH13B	1,3 8-1/4	

① Sistema "Venturi".

ZL



GENERATORE VUOTO

COD. ART.	aspiraz.	PREZZO
ZL112	100 lt min.	

① raccordo alimentazione mm 6
raccordo asp. per vuoto mm 12
Sistema "Multistadio" = basso consumo.

ZM

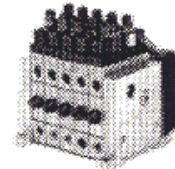

GEN. VUOTO MODULARI

COD. ART.	PREZZO

① Modelli con accessori.

PVA



GENERATORE VUOTO

COD. ART.	Filetto	PREZZO
70PVA	1/8	
80PVA	1/4	

① Sistema "Venturi". - Ventosa esclusa.

VRV

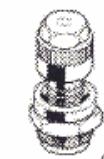

VALVOLA REGOLAZIONE VUOTO

COD. ART.	Filetto	PREZZO
VRV8	1/8	
VRV2	1/2	
VRV7	3/4	
VRV1	1"	

①

RVV



RIDUTTORE DI VUOTO

COD. ART.	Filetto	PREZZO
RVV4	1/4	
RVV3	3/8	
RVV2	1/2	
RVV7	3/4	
RVV1	1"	

① Vuotometro a richiesta.

FAB



FILTRO ASPIRAZIONE

COD. ART.	Filetto	PREZZO
FAB4	1/4	
FAB3	3/8	
FAB2	1/2	
FAB7	3/4	
FAB1	1"	

① Disponibili anche altri modelli.

VR



VUOSTATO -MINI-

COD. ART.	Vuoto	PREZZO
VR02A	150-700 mm hg	
VR02C	150-700 mm hg	

① PR000 cuffia gomma
VR02A = norm. ap. • VR02C = norm. chiuso
A richiesta: esecuzioni e modelli diversi.

ZSE



SENSORE DIGITALE VUOTO

COD. ART.	bar	PREZZO
ZSE	0.1	

①

UAG



VALVOLA 3/2 VIE SERVOCOM. Nc/Na

COD. ART.	Filetto	PREZZO
UAG3071	1/8	
UAG3073	1/4	
UAG3075	3/8	
UAG3081	1/2	
UAG3091	3/4	
UAG3101	1"	
UAG3111	1" 1/2	

①

UAG



EL. VALVOLA 3/2 VIE SERVOCOM. Nc/Na

COD. ART.	Filetto	PREZZO
UAG3001	1/8	
UAG3003	1/4	
UAG3005	3/8	
UAG3021	1/2	
UAG3041	3/4	
UAG3051	1"	

① A richiesta: bobina U2 e connettore.

UAG



EL. VALVOLA 3/2 VIE NC

COD. ART.	Filetto	PREZZO
UAG3202	1/4	
UAG3206	3/8	
UAG3222	1/2	
UAG3232	3/4	
UAG3242	1"	
UAG3252	1" 1/2	

① A richiesta: bobina U2 e connettore.

ZPT



SUPPORTO ANTIROTAZIONE COMPLETO

COD. ART.	∅ mm	PREZZO
ZPT10	10	
ZPT16	16	
ZPT20	20	
ZPT25	25	
ZPT32	32	

① Disponibili con raccordo verticale.
Ventose plane o con nervature di rinforzo.

DATI DI FORZA DELLE VENTOSE IN KG

∅ = kg	∅ = kg	∅ = kg	∅ = kg
4 0,03	16 0,50	32 2,00	52 5,30
5 0,05	18 0,63	33 2,13	60 7,10
6 0,07	19 0,70	35 2,40	65 8,20
8 0,12	20 0,78	40 3,14	75 11,04
10 0,19	22 0,95	45 3,98	80 12,60
12 0,28	25 1,23	48 4,52	85 14,18
15 0,44	30 1,75	50 4,90	100 19,62

CLV



CENTRO-LAVORO A VENTOSA

COD. ART.	∅ Ventosa	PREZZO
CLV040	40	
CLV085	85	
CLV110	110	
CLV120	120	
CLV150	150	

① A richiesta: modelli rettangolari.

VSS



VENTOSA SENZA SUPPORTO

COD. ART.	∅ mm	PREZZO
VSS04*	4	
VSS06*	6	
VSS08*	8	
VSS10*	10	
VSS13*	13	
VSS16*	16	
VSS20*	20	
VSS25*	25	
VSS30	30	
VSS32*	32	
VSS40*	40	
VSS45	45	
VSS50*	50	
VSS60	60	
VSS85	85	

① Ventose con nervature da mm 10.
*Modelli serie SMC.

VSF



VENTOSA SUPPORTO FIL. FEMM.

COD. ART.	∅ fil.	PREZZO
VSF02*	2 M5	
VSF04*	4 M5	
VSF06*	6 M5	
VSF08*	8 M5	
VSF10*	10 M5	
VDF13*	13 M5	
VSF16*	16 M5	
VSF20*	20 M5-1/8	
VSF25*	25 M5-1/8	
VSF30	30 1/8	
VSF32*	32 M5	
VSF35	35 1/4	
VSF40*	40 1/4-1/8	
VSF45	45 1/4	
VSF50*	50 1/8	

① Ventose con nervature da mm 10.
Per supporto maschio cod. VSM.

VCF



VENTOSA CONICA SUPP. FEMM.

COD. ART.	∅ fil.	PREZZO
VCF10	10 M5	
VCF20	20 1/8	
VCF25	25 M5	
VCF40	40 1/8	
VCF16	16 M5	

① Idonee per oggetti a superficie sferica o curva.
NBR - PARA - SILICONE

VSM



VENTOSA A SOFFIETTO FIL. M/F

COD. ART.	∅ fil.	PREZZO
VSM10	10 M5-1/8	
VSM16	16 M5-1/8	
VSM20	20 M5-1/8	
VSM30	30 M5-1/8	
VSM40	40 M5-1/8	
VSM50	50 M5-1/8	

① NBR - PARA - SILICONE



VALVOLE - ELETTROVALVOLE PNEUMATICHE MINI e ISO

MEK

VALVOLA MONOSTABILE 5 VIE 1 COMANDO PN

COD. ART.	filetto	posizione	PREZZO
MEKCA8KRTQ	1/8	2 pos. C.A.	

MINI

① Filetto di pilotaggio M5.

MEK

VALVOLA BISTABILE 5 VIE 2 COMANDO PN

COD. ART.	filetto	posizione	PREZZO
MEKCA8KRKR	1/8	2 pos. C.A.	
MEKCA8SRSR	1/8	3 pos. C.CH.	
MEKCA8UAU	1/8	3 pos. C.AP.	

MINI

① Filetto di pilotaggio M5.

MEK

EL.VALVOLA MONOSTABILE 5 VIE 1 COMANDO EL.

COD. ART.	filetto	posizione	PREZZO
MEKCA8KUTQ	1/8	2 pos. C.A.	

MINI

①

MEK

EL.VALVOLA BISTABILE 5 VIE COMANDO EL.

COD. ART.	filetto	posizione	PREZZO
MEKCA8KUKU	1/8	2 pos. C.A.	
MEKCA8SUSU	1/8	3 pos. C.CH.	
MEKCA8UAU	1/8	3 pos. C.AP.	

MINI

①

ELETTROPILOTA

COD. ART.	filetto	posizione	PREZZO
UMCSV		elettropilota	
MEK192		connettore	

① Voltaggi: 24V cc - 24V 50/60 - 110V 50/60 - 220V 50/60

MEK

SOTTOBASE

COD. ART.	filetto	posizioni	PREZZO
MEK82	1/8	2	
MEK83	1/8	3	
MEK84	1/8	4	
MEK85	1/8	5	
MEK86	1/8	6	
MEK88	1/8	8	
MEKPC		piastra chiusura	

①

UDS105

VALVOLA MONOSTABILE 5 VIE 1 COMANDO PN

COD. ART.	posizione	PREZZO
UDS105KRZR	2 posiz. C.A.	

ISO-1

①

UDS105

EL.VALVOLA MONOSTABILE 5 VIE 1 COMANDO EL.

COD. ART.	posizione	PREZZO
UDS105KUZR	2 posiz. C.A.	

ISO-1

①

COD. ART.	posizione	PREZZO

ISO-1

①

UDS105

EL.VALVOLA BISTABILE 5 VIE COMANDO EL.

COD. ART.	posizione	PREZZO
UDS105KUKU	2 posiz. C.A.	
UDS105SUSU	3 posiz. C.CH.	
UDS105UAU	3 posiz. C.AP.	

ISO-1

①

ELPG8S

EL.PILOTA RICAMBIO VALVOLE ISO

COD. ART.	posizione	PREZZO
ELPG8S		

① Voltaggi: 24V cc - 24V 50/60 - 110V 50/60 - 220V 50/60

UDPISO

BASE ISO

COD. ART.	filetto	posizione	PREZZO
UDPISO18	1/8		
UDPISO14	1/4		
UDPISO24	1/4		
UDPISO23	3/8		

①

UDS212

VALVOLA MONOSTABILE 5 VIE 1 COMANDO PN

COD. ART.	posizione	PREZZO
UDS212KRZ	2 posiz. C.A.	

ISO-2

①

UDS212

EL.VALVOLA MONOSTABILE 5 VIE 1 COMANDO EL.

COD. ART.	posizione	PREZZO
UDS212KUZR	2 posiz. C.A.	

ISO-2

①

UDS212

VALVOLA BISTABILE 5 VIE 2 COMANDI PN

COD. ART.	posizione	PREZZO
UDS212KRKR	2 posiz. C.A.	
UDS212SRSR	3 posiz. C.CH.	
UDS212ARAR	3 posiz. C.AP.	

ISO-2

①

UDS212

EL.VALVOLA BISTABILE 5 VIE COMANDO EL.

COD. ART.	posizione	PREZZO
UDS212KUKU	2 posiz. C.A.	
UDS212SUSU	3 posiz. C.CH.	
UDS212UAU	3 posiz. C.AP.	

ISO-2

①